



Application Guide



ABOUT US

Alliant Power was established in 2002 as a result of a strategic partnership with Caterpillar Fuel Systems, granting Alliant Power exclusive rights to supply new, original equipment HEUI injectors for popular Ford and Navistar diesel vehicles to the aftermarket. Since 2002, the Alliant Power product line has grown considerably. We lead the aftermarket in original equipment or equivalent quality products: fuel systems, engine components, and value-add repair solutions.

WHERE TO BUY

Alliant Power has cultivated an extensive network of 500+ independent diesel specialists to provide Alliant Power product and service solutions throughout the Americas. Please visit our Dealer Locator at alliantpower.com to find an Authorized Dealer in your area. Please contact Alliant Power at **1.866.283.1785** if you are interested in becoming an Authorized Dealer.

VALUE-ADD PRODUCT SOLUTIONS

Alliant Power takes great pride in supplying our valued customers only OEM or equivalent quality products. Where possible, Alliant Power provides added value by offering cost effective repair solutions and kitting strategies. Look for the emblems below throughout this Application Guide highlighting these strategic product solutions.

EXCLUSIVE PARTS

Oftentimes, OEMs restrict product access or offer only expensive replacement components to fix engine issues. With this in mind, Alliant Power strives to create unique, exclusive product solutions enabling cost effective, quality repairs alternative to expensive component replacement – saving our customers time and money.

EXCLUSIVE KITS

Alliant Power assembles kits to include all components necessary to complete a specific repair. These kits include not only the replacement component but also all necessary seals, gaskets, and hardware for proper installation. Save time and money—when you order these exclusive kits from Alliant Power, you can be sure you have all of the necessary parts to do the job right!

PROFESSIONAL TECHNICAL SUPPORT

Alliant Power offers a comprehensive technical support program to assist customers with vehicle diagnostic troubleshooting, part number cross-referencing, and training for sales staff and technicians. Technical Bulletins relating to common engine diagnostic issues are available at alliantpower.com. Technical phone support is available at **1.866.283.1785**.

BEST IN CLASS WARRANTY

Alliant Power offers a best in class 24-month, unlimited mileage warranty* on all products. Alliant Power favorably calculates warranty labor reimbursement using flat rate labor time at the installer's shop rate. *Please visit AlliantPower.com for additional details regarding warranty coverage.

FORD





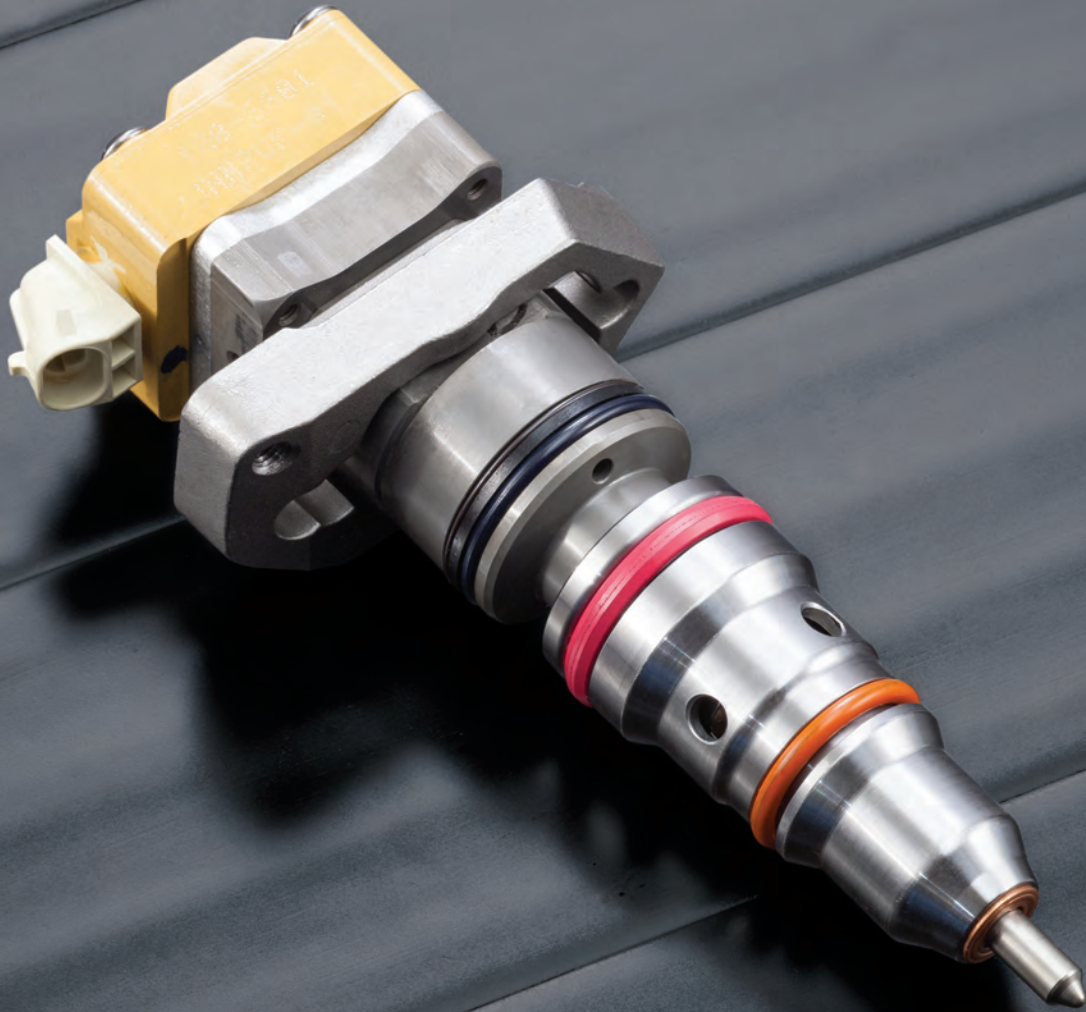

New OEM HEUI® injectors available exclusively through Alliant Power

- ▶ Brand new original equipment HEUI injectors
- ▶ Complete 1994 to 2003 Ford HD – Pickup and van coverage
- ▶ Available exclusively through Alliant Power
- ▶ 24-month, unlimited mileage warranty in Ford applications



7.3L POWER STROKE

Injectors

HEUI Injector*

OEM Part Numbers: F81Z9E527DRM, F4TZ9VE527AARM, F7TZ9E527ARM

Year Range:	Application:
1994–1998	F Series
1994–1996	F Series (California)
1994–1996	E Series

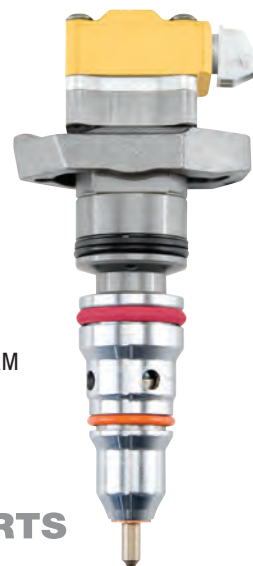

AP63800AA

HEUI Injector*

OEM Part Numbers: F81Z9E527BRM, F7TZ9E527BRM, F61Z9VE527BRM, F61Z9VE527ERM

Notes: Prime (Split Shot) Injector. Engines built BEFORE 12/07/1998.

Year Range:	Application:
1999	F Series
1997–1999	F Series (California)
1997–1998	E Series

EXCLUSIVE PARTS

AP63801AB

HEUI Injector*

OEM Part Numbers: F81Z9E527CRM, 5C3Z9VE527BRM

Notes: Prime (Split Shot) Injector. Engines built AFTER 12/07/1998.

Year Range:	Application:
1999–2003	F Series, E Series



AP63803AD

HEUI Injector*

OEM Part Numbers: F81Z9E527EARM, XC3Z9E527AARM, 5C3Z9VE527ARM

Notes: Long Lead (LL or blue harness connector) Injector. Engines built AFTER 12/07/1998. Used in #8 cylinder to eliminate “cackle” (Per Ford Bulletins 00–10–1, 00–22–1, and 01–14–6).

Year Range:	Application:	ESN Range:
1999–2003	F Series	661,496 to 896,812
1999–2003	E Series	661,974 to 896,812

AP63804AE

Modules

Glow Plug Control Module (GPCM)

OEM Part Numbers: YC3Z12B533AA, DY876

Notes: Field data indicates Glow Plug Control Modules (GPCMs) were used on some 2000 to 2003 vehicles.

Year Range:	Application:
2000–2003	F–250 / F–550, Excursion, E Series



AP63406

**Indicates products with a core charge.*

7.3L POWER STROKE

Modules continued

AP65110



Remanufactured Injector Drive Module (IDM)*

OEM Part Numbers: F7TZ12B599AC, HC2Z12B599BRM

Year Range:
1994½–1998

Application:
F Series, E Series

AP65120



Remanufactured Injector Drive Module (IDM)*

OEM Part Numbers: XC3Z12B599AA, 2C2Z12B599A, HC2Z12B599ARM

Year Range:
1999–2003

Application:
F Series, Excursion, E Series

Fuel System Components

APM61067



Fuel Transfer Pump–Mechanical

OEM Part Numbers: F6TZ9350A, YC3Z9350CA

Notes: Includes two banjo gaskets.

Year Range:
1994–1998

Application:
F Series, E Series

69136



Fuel Transfer Pump–Electronic

OEM Part Numbers: F81Z9C407AC, 0 580 464 074

Year Range:
1993–2003

Application:
F Series, Excursion, E Series

AP63409



Fuel Filter Heater Element

OEM Part Number: F5TZ9J294A

Notes: Field data indicates both elements (AP63409 and AP63410) were used for MY 1998 vehicles. Be sure to verify which element is in place.

Year Range:
1994–1998

Application:
F Series, E Series

AP63410



Fuel Filter Heater Element

OEM Part Number: F81Z9J294AA

Notes: Field data indicates both elements (AP63409 and AP63410) were used for MY 1998 vehicles. Be sure to verify which element is in place.

Year Range:
1998–2003

Application:
F Series, Excursion, E Series

**Indicates products with a core charge.*

7.3L POWER STROKE

Engine Components

Exhaust Back Pressure (EBP) Tube

AP63404

OEM Part Number: 1C3Z9D477AA

Year Range:
1999½–2003

Application:
F Series, Excursion, E Series



HEUI Injector Sleeve–Brass

AP63411

OEM Part Number: F4TZ9F538A

Year Range:
1994–2003

Application:
F Series, Excursion, E Series



Engine Oil Cooler

AP63452

OEM Part Number: 1C3Z6A642AA

Notes: Requires AP0004 Engine Oil Cooler O–ring and Gasket Kit for installation.

Year Range:
1994–2003

Application:
F Series, Excursion, E Series



Water Pump

AP63501

OEM Part Numbers: F81Z8501CRM / ARM, F6TZ8501AARM, 2C3Z8V501BA

Notes: Includes mounting gasket. May require heater hose adapter fitting for installation. See Technical Bulletin APTB 04/06.

Year Range:
1994–1995
1996–2003

Application:
F Series, E Series
F Series, Excursion, E Series

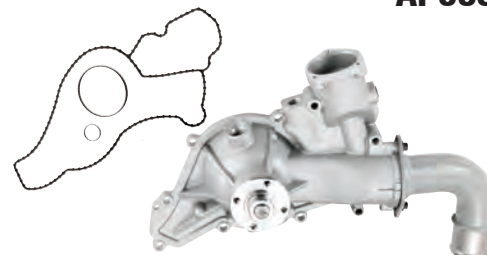

Remanufactured High–Pressure Oil Pump

HP004X

OEM Part Number: F4TZ9A543BRM

Notes: Includes mounting gasket.

Year Range:
1994–1995

Application:
F Series, E Series



Remanufactured High–Pressure Oil Pump

HP005X

OEM Part Number: F6TZ9A543ARM

Notes: Includes mounting gasket.

Year Range:
1996–1997

Application:
F Series, E Series



7.3L POWER STROKE

Engine Components continued

HP007X



Remanufactured High-Pressure Oil Pump

OEM Part Number: F81Z9A543BRM

Notes: Includes mounting gasket.

Year Range:
1998–1999½

Application:
F Series, E Series

HP008X



Remanufactured High-Pressure Oil Pump

OEM Part Number: F81Z9A543CRM

Notes: Includes mounting gasket.

Year Range:
1999½–2003

Application:
F Series, Excursion, E Series

Sensors

AP63490



Ambient Air Temperature (AAT) Sensor

OEM Part Numbers: 9U2Z12A648A, DY1145

Year Range:
1994–1998

Application:
F Series

AP63491



Camshaft Position (CMP) Sensor

OEM Part Numbers: F4TZ12K073C, DU87

Year Range:
1994–1996

Application:
F Series

AP63400



Camshaft Position (CMP) Sensor

OEM Part Numbers: F7TZ12K073A / B

Year Range:
1997–2003
2000–2003
2000–2003
1997–2003

Application:
F–250 / F–550
F–650 / F–750
Excursion
E Series

ESN Range:
375,549 to 2,030,402
1,026,248 to End
896,813 to 2,030,402
375,549 to 2,030,402

7.3L POWER STROKE

continued **Sensors**

Engine Oil Pressure (EOP) Sensor

OEM Part Numbers: F81Z9278AA, SW5267

Year Range:
1994–2003

Application:
F Series, Excursion, E Series



AP63435

Engine Oil Temperature (EOT) Sensor

OEM Part Numbers: F5AZ12A648AB, 3F1Z12A648A, DY961, DY1144

Year Range:
1994–2003

Application:
F Series, Excursion, E Series

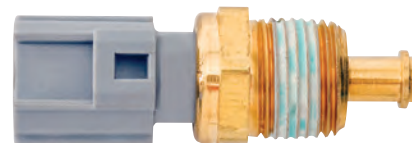

AP63436

Pressure Sensor

OEM Part Numbers: 1C3Z9J460AA, DPFE1

Notes: Exhaust Back Pressure (EBP).

Year Range:
1994–1997

Application:
F Series, E Series



AP63429

Exhaust Back Pressure (EBP) Sensor

OEM Part Numbers: 4C3Z9J460A, DPFE3

Year Range:
1997–2002
2000–2002
2000–2002
1995–2003

Application:
F–250 / F–550
F–650 / F–750
Excursion
E Series

ESN Range:
501 to 2,030,402
1,026,248 to End
896,813 to 2,030,402
35,651 to 2,030,402



AP63403

Injection Control Pressure (ICP) Sensor

OEM Part Number: F6TZ9F838A

Year Range:
1999–2002
2000–2002
2000–2002
1995–2003

Application:
F–250 / F–550
F–650 / F–750
Excursion
E Series

ESN Range:
661,974 to 2,030,402
1,026,248 to End
896,813 to 2,030,402
35,651 to 2,030,402



AP63418

Manifold Absolute Pressure (MAP) Sensor

OEM Part Numbers: F4TZ9F479A, DY708

Year Range:
1994–1998

Application:
F Series, E Series



AP63489

7.3L POWER STROKE

Sensors continued

AP63492



Manifold Absolute Pressure (MAP) Sensor

OEM Part Numbers: F8UZ9F479BA, CX1679

Year Range:
1998–2003

Application:
F Series, Excursion

Actuators

AP63401



Injection Pressure Regulator (IPR) Valve

OEM Part Numbers: F4TZ9C968C / CB, 2C3Z9C968BA

Notes: With edge filter.

Year Range:
1994–1995½

Application:
F Series, E Series

ESN Range:
0 to 187,099

AP63402



Injection Pressure Regulator (IPR) Valve

OEM Part Numbers: F81Z9C968AA / AB

Notes: Without edge filter.

Year Range:
1995½–2003

Application:
F Series, Excursion,
E Series

ESN Range:
187,100 to End

AP63405



Glow Plug Relay

OEM Part Numbers: F81Z12B533AC, F7TZ12B533A / CA, DY861, RY525

Year Range:
1994–2003
2000–2002
2000–2002
1995–2003

Application:
F–250 / F–550
F–650 / F–750
Excursion
E Series

Electrical Harness and Repair

AP0009 **EXCLUSIVEKITS**



Valve Cover Harness Connector Repair Kit

Notes: Repairs AP0016 Valve Cover Gasket Connector Pigtail.

Year Range:
1998–2003

Application:
F Series, Excursion, E Series.

AP0010 **EXCLUSIVEKITS**



Valve Cover Harness Connector Repair Kit

Notes: Repairs AP0015 Valve Cover Gasket Connector Pigtail.

Year Range:
1994–1997

Application:
F Series, E Series

7.3L POWER STROKE

continued **Electrical Harness and Repair**

Valve Cover Gasket Connector Pigtail

Year Range: 1994–1997
Application: F Series, E Series

EXCLUSIVEPARTS AP0015



Valve Cover Gasket Connector Pigtail

Year Range: 1998–2003
Application: F Series, Excursion, E Series

EXCLUSIVEPARTS AP0016

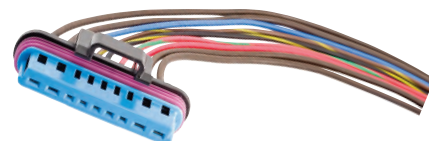

3 Wire Pigtail

OEM Part Number: 5C3Z12224A

Notes: Fits AP63418 Injection Control Pressure (ICP) Sensor as well as AP63403 Exhaust Back Pressure (EBP) Sensor, and AP63429 Pressure Sensor.

Year Range: 1994–2003
Application: F Series, Excursion, E Series

AP0021



2 Wire Pigtail

Notes: Fits AP63401 and AP63402 Injection Pressure Regulator (IPR) Valves and all HEUI A Injectors.

Year Range: 1994–1995½
 1995½–2003
Application: F Series, E Series
 F Series, Excursion, E Series
ESN Range: 0 to 187,099
 187,100 to End

AP0068



Internal Injector Harness

OEM Part Number: F81Z9D930AB

Notes: Use with AP0014 Valve Cover Gasket Kit.

Year Range: 1998–2003
Application: F Series, Excursion, E Series

AP63413



Internal Injector Harness

OEM Part Number: F4TZ9D930K

Notes: Use with AP0013 Valve Cover Gasket Kit.

Year Range: 1994–1997
Application: F Series, E Series

AP63414



7.3L POWER STROKE

Seal and Gasket Kits

AP0001



HEUI Injector Seal Kit

OEM Part Numbers: F8TZ9229AA, XC3Z9229AB

Year Range:
1994–2003

Application:
F Series, Excursion, E Series

AP0003



Injection Pressure Regulator (IPR) Valve Seal Kit

OEM Part Numbers: F6TZ9C977AN, 4C3Z9C977AA

Year Range:
1994–2003

Application:
F Series, Excursion, E Series

AP0004

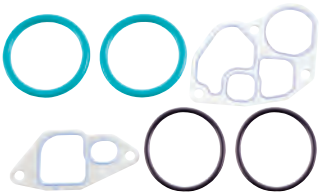

Engine Oil Cooler O-ring and Gasket Kit

OEM Part Numbers: F4TZ6A636A, F7TZ6A636AAA, 1C3Z6C610BA, 1C3Z6K649BA

Year Range:
1994–2003

Application:
F Series, Excursion, E Series

EXCLUSIVEKITS

AP0008

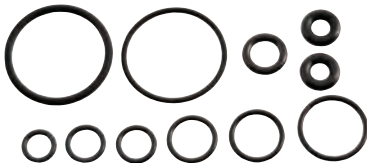

Fuel Filter Drain Valve Kit

OEM Part Numbers: F6TZ9157BA and F5TZ9151A

Year Range:
1994–1997

Application:
F Series, E Series

EXCLUSIVEKITS

AP0007



Fuel Filter Drain Valve Kit

OEM Part Number: F81Z9C065AA

Notes: Includes grommets.

Year Range:
1998–2003

Application:
F Series, Excursion, E Series

AP0011

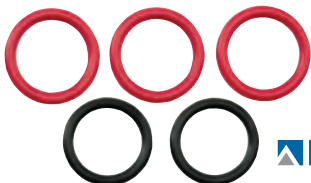

High-Pressure Oil Pump Seal Kit

OEM Part Number: 2C3Z9G804AB

Year Range:
1994–2003

Application:
F Series, Excursion, E Series

EXCLUSIVEKITS

7.3L POWER STROKE

continued **Seal and Gasket Kits**

Valve Cover Gasket Kit

OEM Part Number: F4TZ6584A

Notes: Use with AP63414 Internal Injector Harness. Package of two.

Year Range:
1994–1997

Application:
F Series, E Series

AP0013

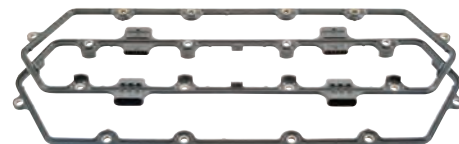

Valve Cover Gasket Kit

OEM Part Number: F81Z6584AA

Notes: Use with AP63413 Internal Injector Harness. Package of two.

Year Range:
1998–2003

Application:
F Series, Excursion, E Series

AP0014



Turbo Installation Kit

OEM Part Number: F81Z6N653BA

Year Range:
1999–2003

Application:
F Series, Excursion, E Series

AP63461

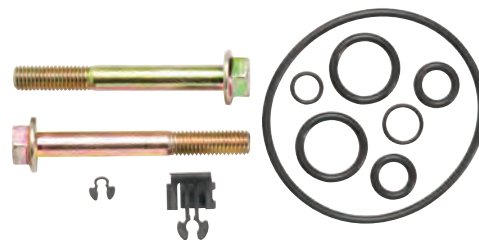

Engine Accessories

Belt Tensioner

OEM Part Numbers: F8UZ6B209CA, BT50

Year Range:
1998–2003
2000–2003

Application:
F Series, E Series
Excursion

AP63421



Vacuum Pump—Electronic

OEM Part Numbers: 6C3Z2A451A, 6C3A2A451BA, F81Z2A451BA, 4C3Z2A451BA, BRPV-7

Year Range:
1998–2003

Application:
F Series, Excursion, E Series

AP63433



7.3L POWER STROKE

Engine Accessories continued

AP63700



Vacuum Pump—Mechanical

OEM Part Numbers: F6T22A451AA, BRPV-6

Year Range:	Application:
1998–2002	F–250 / F–450
2000–2002	F–550
1996–2002	E–350
2002	E–450 / E–550

AP63724



Vacuum Pump—Mechanical

OEM Part Numbers: F4T22A451A, BRPV-5

Year Range:	Application:
1994–1998	F Series, E Series

Filters

PFF829B

RACOR



Spin-on Fuel Filter/Water Separator

OEM Part Number: FD3375

Notes: Only fits 7.3L IDI Diesel.

Year Range:	Application:
1988–1994	F Series, E Series

PFRK20567

RACOR



Fuel Filter Bowl/Drain Assembly

Notes: Use with PFF829B Spin-on Fuel Filter/Water Separator. Only fits 7.3L IDI Diesel.

Year Range:	Application:
1988–1994	F Series, E Series

PFF4595

RACOR



Fuel Filter Element Service Kit

OEM Part Number: FD4495

Year Range:	Application:
1994–1999	F Series, E Series

7.3L POWER STROKE

continued **Filters**

Fuel Filter Top Cover

OEM Part Number: F5TZ9G270A

Year Range:
1994–1998

Application:
F Series, E Series

RACOR.



RK31019



Fuel Filter Element Service Kit

OEM Part Number: FD4596

Year Range:
1999–2003

Application:
F Series, Excursion, E Series

RACOR.



PFF4596



Fuel Filter Top Cover

Year Range:
1998½–2003

Application:
F Series, Excursion, E Series

RACOR.



RK31449



Fuel Filter Housing Assembly

OEM Part Numbers: F6TZ9155AB, FG1054

Notes: Includes PFF4595 Fuel Filter Element Service Kit, RK31019 Fuel Filter Top Cover, and AP63409 Fuel Filter Heater Element. Field data indicates both housings (AP63424 and AP63425) were used for MY 1998 vehicles. Be sure to verify which housing is in place.

Year Range:
1994–1998

Application:
F Series



AP63424

Fuel Filter Housing Assembly

OEM Part Numbers: F81Z9155AC, FG1057

Notes: Includes PFF4596 Fuel Filter Element Service Kit, RK31449 Fuel Filter Top Cover, and AP63410 Fuel Filter Heater Element. Field data indicates both housings (AP63424 and AP63425) were used for MY 1998 vehicles. Be sure to verify which housing is in place.

Year Range:
1998½–2003

Application:
F Series, Excursion, E Series



AP63425



NEW

Injector Coils



NEW

Connector



NEW

Spool Valve

Alliant Power partners with PurePower Technologies®!

PurePower's industry leading remanufactured G2.8 injectors now available to the aftermarket through Alliant Power.

- ▶ Remanufactured by PurePower Technologies:
 - 100% new coil and harness assemblies with vented slot technology
 - 100% new spool valve and connector
 - 24-month, unlimited mileage warranty in Ford applications
- ▶ Brand new injectors also available



6.0L and 4.5L POWER STROKE

Injectors

PPT Remanufactured G2.8 Injector* PPT New G2.8 Injector*

OEM Part Numbers: 3C3Z9E527EBRM / EARM / AE / ABRM / ECRM, 6901-PP, 6918-PP

Notes: Engines built BEFORE 09/22/2003.

Year Range:	Application:	ESN Range:
2003-09/21/2003	F-250 / F-550, Excursion	0 to 137,745 (Alabama built)
2003-09/21/2003	F-250 / F-550, Excursion	6,000,000 to 6,155,636 (Indiana built)
2003-09/21/2003	F-650 / F-750	0 to 112,360 (Alabama built)

AP60900
AP60800



PPT Remanufactured G2.8 Injector* PPT New G2.8 Injector*

OEM Part Numbers: 4C3Z9E527AA / BRM, 7E7Z9E527AA, 6902-PP, 6919-PP

Notes: Engines built ON or AFTER 09/22/2003.

Year Range:	Application:
09/22/2003-2007	F-250 / F-550, Excursion
2005-2007	F-650 / F-750
2004-2010	E Series
2006-2010	4.5L LCF

purePOWER
TECHNOLOGIES

AP60901
AP60801

Modules

Glow Plug Control Module (GPCM)

OEM Part Numbers: YC3Z12B533AA, DY876

Year Range:	Application:
2003-2007	F-250 / F-550, Excursion
2004-2010	E Series

AP63406



**Indicates products with a core charge.*

6.0L and 4.5L POWER STROKE

Modules continued

AP65122



Remanufactured Fuel Injection Control Module (FICM)*

OEM Part Numbers: 4C3Z12B599ABRM / AB / CRM / AARM

Notes: Pre-programmed. Engines built BEFORE 09/22/2003.

Year Range: 2003–09/21/2003
Application: F–250 / F–550, Excursion

AP65123

Remanufactured Fuel Injection Control Module (FICM)*

OEM Part Numbers: 4C3Z12B599ABRM / AB / DRM

Notes: Pre-programmed. Engines built ON or AFTER 09/22/2003.

Year Range: 09/22/2003–2004
 09/22/2003–01/31/2005
Application: F–250 / F–550
 Excursion

AP65124

Remanufactured Fuel Injection Control Module (FICM)*

OEM Part Numbers: 4C3Z12B599ABRM / AB / ERM

Notes: Pre-programmed.

Year Range: 2005–2007
 02/01/2005–2005
 2004–2010
Application: F–250 / F–550
 Excursion
 E Series

Engine Components

AP63445 **EXCLUSIVEKITS**

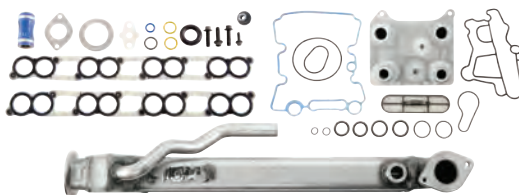

Oil Cooler/Exhaust Gas Recirculation (EGR) Cooler Kit*

Notes: Includes AP63451 Engine Oil Cooler Kit and AP63446 Exhaust Gas Recirculation (EGR) Cooler Kit. Core required only on the Exhaust Gas Recirculation (EGR) Cooler.

Year Range: 2004–2007
 2004–2010
Application: F Series, Excursion
 E Series

AP63446 **EXCLUSIVEKITS**



Exhaust Gas Recirculation (EGR) Cooler Kit*

OEM Part Numbers: 4C3Z9P456AF / AC / AH / AJ

Notes: Includes AP63447 Exhaust Gas Recirculation (EGR) Cooler Intake Gasket Kit.

Year Range: 2004–2007
 2004–2010
Application: F Series, Excursion
 E Series

AP63451

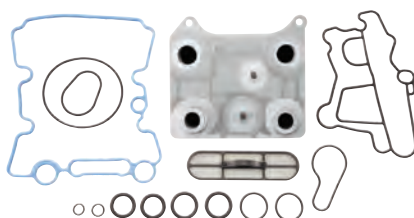

Engine Oil Cooler Kit

OEM Part Number: 3C3Z6A642CA

Notes: Includes AP0039 Engine Oil Cooler Gasket Kit.

Year Range: 2003–2007
 2004–2010
 2006–2010
Application: F Series, Excursion
 E Series
 4.5L LCF

6.0L and 4.5L POWER STROKE

continued **Engine Components**

Turbo Hose–Short

OEM Part Numbers: 6C3Z6C640C / CA

Year Range: 2003–2004
Application: F Series, Excursion

AP63454



Turbo Hose–Long

OEM Part Numbers: 6C3Z6C640A / AA

Year Range: 2004½–2007
Application: F Series, Excursion

AP63455



Thermostat

OEM Part Numbers: 3C3Z8575AA, RT1169

Year Range: 2003–2007
 2004–2010
Application: F Series
 E Series

AP63496

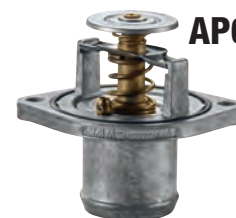

Water Pump

OEM Part Numbers: 3C3Z8501A, PW480

Notes: Includes mounting gasket. F–650 / F–750 use AP63583 Water Pump Navistar VT365.

Year Range: 2003–07/19/2004
 2004–07/19/2004
Application: F–250 / F–550, Excursion
 E Series

AP63502



Water Pump

OEM Part Numbers: 4C3Z8501AC, PW491

Notes: Includes mounting gasket. F–650 / F–750 use AP63583 Water Pump Navistar VT365.

Year Range: 07/20/2004–2007
 07/20/2004–2010
 2006–2010
Application: F–250 / F–550, Excursion
 E Series
 4.5L LCF

AP63503

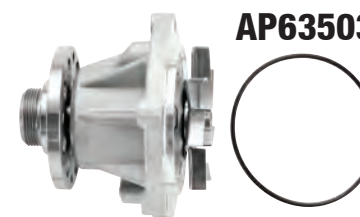

Remanufactured High–Pressure Oil Pump*

OEM Part Numbers: 5C4Z9A543A / B, 5C3Z9A543C / ARM

Notes: Includes seal kit.

Year Range: 2004½–2007
 2004½–2010
Application: F Series, Excursion
 E Series

AP63661

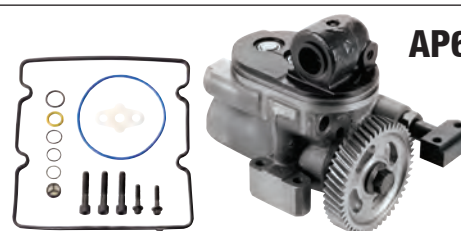

*Indicates products with a core charge.

6.0L and 4.5L POWER STROKE

Engine Components continued

AP63662

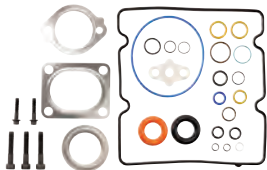

Remanufactured High-Pressure Oil Pump*

OEM Part Number: 6E7Z9A543BRM

Notes: Includes seal kit.

Year Range:
2006–2007

Application:
4.5L LCF

AP63663

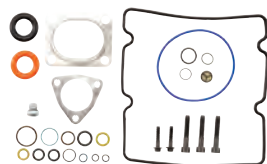

Remanufactured High-Pressure Oil Pump*

OEM Part Number: 8E7Z9A543CRM

Notes: Includes seal kit.

Year Range:
2008–2010

Application:
4.5L LCF

HP032X



Remanufactured High-Pressure Oil Pump

OEM Part Numbers: 3C3Z9A543AARM, 4C3Z9A543AARM

Notes: Includes seal kit.

Year Range:
2003–2004

Application:
F Series, Excursion, E Series

Please visit AlliantPower.com for
up-to-date New Product Announcements,
Sales Flyers and Technical Bulletins.



*Indicates products with a core charge.

6.0L and 4.5L POWER STROKE

Sensors

Engine Speed/Position Sensor

OEM Part Numbers: 3C3Z6C315AA, DY985

Notes: Crankshaft Speed/Position.

Year Range:	Application:
2003–2007	F Series, Excursion
2004–2010	E Series
2006–2010	4.5L LCF



AP63412

Engine Speed/Position Sensor

OEM Part Numbers: 3C3Z12K073AA, 8C3Z12K073A, DU88

Notes: Camshaft Speed/Position.

Year Range:	Application:
2003–2007	F Series, Excursion
2004–2010	E Series
2006–2010	4.5L LCF



AP63415

Ambient Air Temperature (AAT) Sensor

OEM Part Numbers: AE5Z12A647A, DY1137

Year Range:	Application:
2004½–2008	F Series
2006–2008	E Series



AP63493

Engine Oil Pressure (EOP) Sensor

OEM Part Numbers: F81Z9278AA, SW5267

Year Range:	Application:
2003–2007	F Series, Excursion
2004–2010	E Series
2006–2010	4.5L LCF



AP63435

Engine Oil/Coolant/Fuel Temperature (EOT/ECT/FT) Sensor

OEM Part Numbers: 3C3Z10884AA, SW6052

Year Range:	Application:
2003–2007	F Series, Excursion
2004–2010	E Series
2006–2010	4.5L LCF

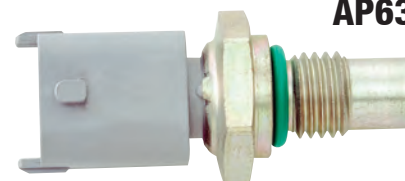

AP63437

Exhaust Back Pressure (EBP) Sensor

OEM Part Numbers: 4C3Z9J460A, DPFE3

Year Range:	Application:	ESN Range:
2003–2004	F Series, Excursion	6,000,000 to 6,344,942
2004	E Series	0 to 149,760



AP63403

6.0L and 4.5L POWER STROKE

Sensors continued

AP63408



Exhaust Back Pressure (EBP) Sensor

OEM Part Numbers: 5C3Z9J460A / B, DPFE6

Year Range:

2005–2007

2003–2007

2004–2010

Application:

F–250 / F–550, Excursion

F–650 / F–750

E Series

ESN Range:

6,344,943 to End

149,761 to End

AP63407



Injection Control Pressure (ICP) Sensor

OEM Part Number: 3C3Z9F838EA

Notes: Mounts below turbo.

Year Range:

2003–2004

Application:

F Series, Excursion

AP63460

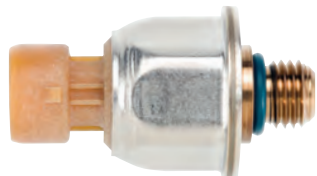

Injection Control Pressure (ICP) Sensor

OEM Part Numbers: 4C3Z9F838A / AB

Notes: Mounts on passenger side valve cover.

Year Range:

2004–2007

2004–2010

2006–2010

Application:

F Series, Excursion

E Series

4.5L LCF

AP63462

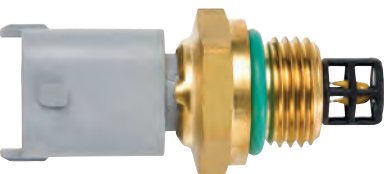

Intake Manifold Air Temperature (IAT) Sensor

OEM Part Numbers: 3C3Z12A697AA, DY984

Year Range:

2003–2010

2006

Application:

F Series, Excursion, E Series

4.5L LCF

AP63463



Intake Manifold Air Temperature (IAT) Sensor

OEM Part Numbers: 8C3Z12A697B, DY1112

Year Range:

2007–2010

Application:

4.5L LCF

AP63495



Manifold Absolute Pressure (MAP) Sensor

OEM Part Numbers: 2L1Z9F479AA, CX1961

Year Range:

2003–2007

2003–2005

2003–2010

Application:

F Series

Excursion

E Series

6.0L and 4.5L POWER STROKE

continued **Sensors**

Mass Air Flow (MAF) Sensor*

OEM Part Numbers: 3L3Z12B579ARM, AFLS181RM

Year Range:
2003–2007

Application:
F Series, Excursion



AP63494

Transmission Fluid Temperature Sensor

OEM Part Number: 3C3Z7H141AA

Year Range:
2003–2007
2004–2010

Application:
F Series
E Series



AP63497

Actuators

Injection Pressure Regulator (IPR) Valve

OEM Part Numbers: 3C3Z9C968AA, CM5054

Notes: Without edge filter.

Year Range:
2003–2004

Application:
F Series, Excursion



AP63416



Inlet Screen Detail

Injection Pressure Regulator (IPR) Valve

OEM Part Numbers: 5C3Z9C968CA, CM5126

Notes: With edge filter.

Year Range:
2005–2007
2004–2010
2006–2010

Application:
F Series, Excursion
E Series
4.5L LCF



AP63417



Inlet Screen Detail

Remanufactured Exhaust Gas Recirculation (EGR) Valve*

OEM Part Numbers: 4C3Z9F452A / ARM, CX2056, CX2467RM

Year Range:
2003–2004

Application:
F Series, Excursion



AP63438R

Remanufactured Exhaust Gas Recirculation (EGR) Valve*

OEM Part Numbers: 5C3Z9F452AA / ARM, CX2020, CX2466RM

Year Range:
2004½–2007
2004½–2010

Application:
F–250 / F–550, Excursion
E Series



AP63439R

Turbocharger Vane Actuator

OEM Part Numbers: 5C3Z6F089A / BA, 792593–0001

Year Range:
2003–2007
2004–2010

Application:
F Series, Excursion
E Series



AP91000

*Indicates products with a core charge.

6.0L and 4.5L POWER STROKE

Electrical Harness and Repair

AP0021



3 Wire Pigtail

OEM Part Number: 5C3Z12224A

Notes: Fits AP63407 and AP63460 Injection Control Pressure (ICP) Sensors as well as AP63403 and AP63408 Exhaust Back Pressure (EBP) Sensors.

Year Range:
2003–2007
2004–2010
2006–2010

Application:
F Series, Excursion
E Series
4.5L LCF

AP0056



2 Wire Pigtail

Notes: Fits AP63437 Engine Oil/Coolant/Fuel Temperature (EOT/ECT/FT) Sensor and AP63462 Intake Manifold Air Temperature (IAT) Sensor.

Year Range:
2003–2007
2004–2010
2006–2010

Application:
F Series, Excursion
E Series
4.5L LCF

AP0030



Injector Harness Connector

Year Range:
2003–2007
2004–2010
2006–2010

Application:
F Series, Excursion
E Series
4.5L LCF

EXCLUSIVEPARTS

AP0040



G2.8 Injector Connector

Notes: See Technical Bulletin APTB 03/14 for installation instructions.

Year Range:
2003–2007
2004–2010
2006–2010

Application:
F Series, Excursion
E Series
4.5L LCF

EXCLUSIVEPARTS

AP0018

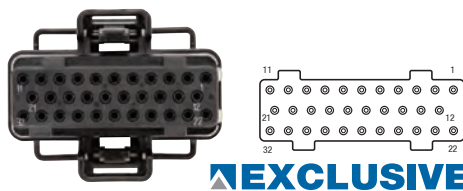

Fuel Injection Control Module (FICM) Connector

Notes: Field data shows identification marks 1456315–6, 1437287–7, or X–3.

Year Range:
2003–2007
2004–2010
2006–2010

Application:
F Series, Excursion
E Series
4.5L LCF

EXCLUSIVEPARTS

AP0019

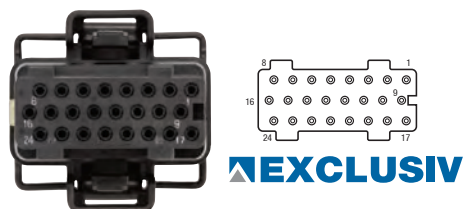

Fuel Injection Control Module (FICM) Connector

Notes: Field data shows identification marks 1456315–2, 1437287–6, or X–2.

Year Range:
2003–2007
2004–2010
2006–2010

Application:
F Series, Excursion
E Series
4.5L LCF

EXCLUSIVEPARTS

6.0L and 4.5L POWER STROKE

continued **Electrical Harness and Repair**

Fuel Injection Control Module (FICM) Connector

Notes: Field data shows identification marks 1456316-1, 1437287-5, or X-1.

Year Range:

2003-2007
2004-2010
2006-2010

Application:

F Series, Excursion
E Series
4.5L LCF

EXCLUSIVEPARTS



AP0020

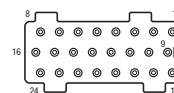

Fuel Injection Control Module (FICM) Connector Pigtail

Notes: Replaces AP0018 Fuel Injection Control Module (FICM) Connector. Field data shows identification marks 1456315-6, 1437287-7, or X-3.

Year Range:

2003-2007
2004-2010

Application:

F Series, Excursion
E Series



AP0031

EXCLUSIVEPARTS

Fuel Injection Control Module (FICM) Connector Pigtail

Notes: Replaces AP0019 Fuel Injection Control Module (FICM) Connector. Field data shows identification marks 1456315-2, 1437287-6, or X-2.

Year Range:

2003-2007
2004-2010

Application:

F Series, Excursion
E Series



AP0032

EXCLUSIVEPARTS

Fuel Injection Control Module (FICM) Connector Pigtail

Notes: Replaces AP0020 Fuel Injection Control Module (FICM) Connector. Field data shows identification marks 1456316-1, 1437287-5, or X-1.

Year Range:

2003-2007
2004-2010

Application:

F Series, Excursion
E Series



AP0033

EXCLUSIVEPARTS

2 Wire Pigtail

Notes: Fits AP63416 and AP63417 Injection Pressure Regulator (IPR) Valves and AP91000 Turbocharger Vane Actuator.

Year Range:

2003-2007
2004-2010
2006-2010

Application:

F Series, Excursion
E Series
4.5L LCF



AP0068

EXCLUSIVEPARTS

6.0L and 4.5L POWER STROKE

Seal and Gasket Kits

AP0002 **EXCLUSIVEKITS**



G2.8 Injector Seal Kit

OEM Part Numbers: 3C3Z9229AA, CM5055

Notes: Includes high-pressure oil seal.

Year Range:	Application:
2003–2007	F Series, Excursion
2004–2010	E Series
2006–2010	4.5L LCF

AP0005



Exhaust Gas Recirculation (EGR) Valve O-ring Kit

OEM Part Number: 3C3Z9P455AB

Year Range:	Application:
2003–2007	F Series, Excursion
2004–2010	E Series

AP0023

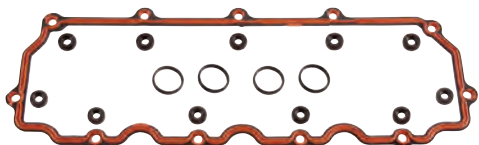

Valve Cover Gasket

OEM Part Number: 3C3Z6584BA

Year Range:	Application:
2003–2007	F Series, Excursion
2004–2010	E Series

AP0028 **EXCLUSIVEKITS**



Stand Pipe and Front Port Plug Seal Kit

OEM Part Numbers: W302209, W301386, and W301390

Notes: Reseals one side.

Year Range:	Application:
2003–2007	F Series, Excursion
2004–2010	E Series
2006–2010	4.5L LCF

AP0035



Injection Pressure Regulator (IPR) Valve Seal Kit

OEM Part Number: 3C3Z9H529A

Year Range:	Application:
2003–2007	F Series, Excursion
2004–2010	E Series
2006–2010	4.5L LCF

AP0039

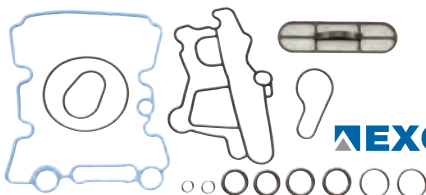

Engine Oil Cooler Gasket Kit

Year Range:	Application:
2003–2007	F Series, Excursion
2004–2010	E Series
2006–2010	4.5L LCF

EXCLUSIVEKITS

6.0L and 4.5L POWER STROKE

continued **Seal and Gasket Kits**

Head Gasket Kit with Studs** Head Gasket Kit without Studs

Notes: 18 mm dowels.

Year Range: 2003–2006
2004–2006

Application: F Series, Excursion
E Series

Kit Contents:

- 2 Cylinder Head Gaskets with 18 mm Dowels
- 2 Exhaust Manifold Gaskets
- 2 Rocker Housing Gaskets
- 1 Secondary Fuel Filter Seal Kit
- 4 Fuel Inlet Copper Washers
- 2 Valve Cover Gaskets
- 8 Injector Seal Kits
- 1 Exhaust Gas Recirculation (EGR) Cooler Intake Gasket Kit
- 1 Exhaust Gas Recirculation (EGR) Valve O-ring Kit
- 2 Stand Pipe and Front Port Plug Seal Kits
- ** Includes Head Stud Kit



EXCLUSIVE KITS AP0043 AP0060

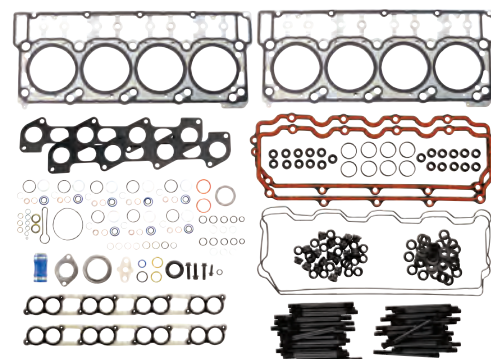

Head Gasket Kit with Studs** Head Gasket Kit without Studs

Notes: 20 mm dowels.

Year Range: 2006–2007
2006–2010

Application: F Series, Excursion
E Series

Kit Contents:

- 2 Cylinder Head Gaskets with 20 mm Dowels
- 2 Exhaust Manifold Gaskets
- 2 Rocker Housing Gaskets
- 1 Secondary Fuel Filter Seal Kit
- 4 Fuel Inlet Copper Washers
- 2 Valve Cover Gaskets
- 8 Injector Seal Kits
- 1 Exhaust Gas Recirculation (EGR) Cooler Intake Gasket Kit
- 1 Exhaust Gas Recirculation (EGR) Valve O-ring Kit
- 2 Stand Pipe and Front Port Plug Seal Kits
- **Includes Head Stud Kit



EXCLUSIVE KITS AP0044 AP0061

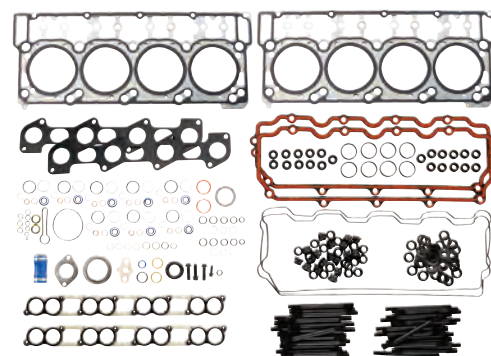

High-Pressure Oil Rail Seal Kit

Notes: AP0069 High-Pressure Oil Rail Socket required for installation.

Year Range: 2003–2007
2004–2010
2006–2010

Application: F Series, Excursion
E Series
4.5L LCF

EXCLUSIVE KITS AP0070



Fuel Pressure Regulator Kit

OEM Part Number: 3C3Z9T517AG

Year Range: 2003–2007
2004–2010

Application: F Series
E Series

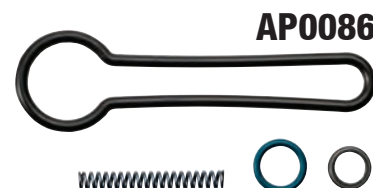

6.0L and 4.5L POWER STROKE

Seal and Gasket Kits continued

AP0098

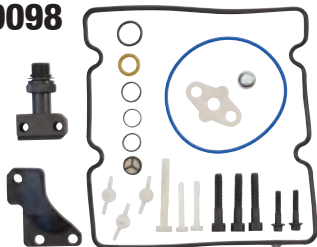

High-Pressure Oil Pump (HPOP) Installation Kit with Fitting

Notes: Includes updated outlet fitting.

Year Range:
2004½–2007
2004½–2010

Application:
F Series, Excursion
E Series

AP0099

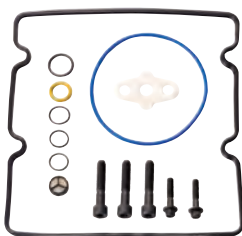

High-Pressure Oil Pump (HPOP) Installation Kit without Fitting

Year Range:
2004½–2007
2004½–2010

Application:
F Series, Excursion
E Series

AP63447



Exhaust Gas Recirculation (EGR) Cooler Intake Gasket Kit

OEM Part Numbers: 3C3Z9433BE / BH

Year Range:
2003–2007
2004–2010

Application:
F Series, Excursion
E Series

EXCLUSIVEKITS

AP63481



Turbo Installation Kit

OEM Part Number: 3C3Z9T514AG

Year Range:
2004–2007
2004–2010

Application:
F Series, Excursion
E Series

Engine Accessories

AP63430



Fan Clutch

OEM Part Numbers: 4C3Z8A616AA, YB632

Year Range:
2003–2007
2004–2010

Application:
F–250 / F–550, Excursion
E Series

AP63432



Belt Tensioner

OEM Part Number: 3C2Z6B209BA

Notes: Dual alternator configurations.

Year Range:
2003–2007
2004–2010

Application:
F–250 / F–550, Excursion
E Series

6.0L and 4.5L POWER STROKE

continued **Engine Accessories**

Belt Tensioner

OEM Part Number: 3C2Z6B209AA

Year Range: 2003–2007
2004–2010

Application: F–250 / F–550, Excursion
E Series



AP63448

Vacuum Pump–Electronic

OEM Part Numbers: 6C3Z2A451A, 6C3A2A451BA, F81Z2A451BA, 4C3Z2A451BA, BRPV–7

Year Range: 2003–2007

Application: F–250 / F–550, Excursion



AP63433

Vacuum Pump–Mechanical

OEM Part Numbers: 4C2Z2A451AA, AC2Z2A451A, BRPV–1 / 11

Year Range: 2004–2010

Application: E Series



AP63703

Starter

OEM Part Numbers: 3C3Z11002AA, 3C3U11000AB, 6C2Z11002AA

Year Range: 2003–2007
2004–2010

Application: F–250 / F–550, Excursion
E Series



AP83006

Filters

Horizontal Fuel Conditioning Module (HFCM)

OEM Part Numbers: 3C3Z9C407AB, 6C3Z9C407AA, 6C3Z9G282AA, PFB93, PFB101

Notes: Field data indicates that some vehicles built BEFORE 09/15/2003 may have three plug connections and would require a new wiring harness (6C3Z9F759A) for installation.

Year Range: 2003–2007

Application: F–250 / F–550



AP63426

Vertical Fuel Conditioning Module (VFCM)

OEM Part Numbers: 6C2Z9G282AA, PFB98, 9C2Z9G282A, 6C3Z9G282C

Year Range: 2004–2010

Application: E Series



AP63431

6.0L and 4.5L POWER STROKE

Filters continued

PFP58565

RACOR



Replacement Fuel Pump

OEM Part Number: 6E7Z9350D

Notes: Does not include housing.

Year Range:
2006–2010

Application:
4.5L LCF

PFF31795



RACOR

Fuel Filter Housing Cap

OEM Part Number: 3C3Z9G270AA

Year Range:
2003–2007
2004–2010
2006–2010

Application:
F–250 / F–550, Excursion
E Series
4.5L LCF

PFF4606

RACOR



Fuel Filter Element Service Kit

OEM Part Number: FD4606

Notes: Primary and secondary.

Year Range:
2004–2010

Application:
E Series

RK58052

RACOR



Replacement Plastic Bowl Assembly with Drain and WIF Sensor

OEM Part Number: 4C2Z9A343AA

Notes: Use with PFF4606 Fuel Filter Element Service Kit.

Year Range:
2004–2010

Application:
E Series

PFF4616

RACOR



Fuel Filter Element Service Kit

OEM Part Number: FD4604

Notes: Primary and secondary.

Year Range:
2003–2007
2006–2010

Application:
F–250 / F–550, Excursion
4.5L LCF

PFL2016

RACOR



Oil Filter Element Service Kit

OEM Part Number: FL2016

Year Range:
2003–2007
2004–2010

Application:
F Series, Excursion
E Series

6.0L and 4.5L POWER STROKE

continued **Filters**

Oil Filter Cap

OEM Part Number: 3C3Z6766CA

Year Range:
2003–2007
2006–2010

Application:
F Series, Excursion
4.5L LCF

RACOR



RK31821



Oil Filter Cap

OEM Part Number: 4C2Z6766BA

Year Range:
2004–2010

Application:
E Series

RACOR



RK32138



Replacement Fuel Pump

OEM Part Number: 6C3Z9C407AA

Notes: Does not include housing.

Year Range:
2003–2007
2004–2010

Application:
F–250 / F–550
E Series

RACOR

PFP58054





Alliant Power partners with PurePower Technologies®!

PurePower's industry leading remanufactured piezo injectors now available to the aftermarket through Alliant Power.

- ▶ Remanufactured by PurePower Technologies
 - Piezos are 100% tested for performance and replaced with new when necessary
 - 24-month, unlimited mileage warranty in Ford applications
- ▶ Brand new injectors also available



6.4L POWER STROKE

Injectors

PPT Remanufactured Piezo Injector*
PPT New Piezo Injector*

OEM Part Numbers: 8C3Z9E527A / DRM, 6903-PP, 6920-PP

Notes: Includes injection line.

Year Range:
2008-2010

Application:
F-250 / F-550



AP64900
AP64800

Modules

Glow Plug Control Module (GPCM)

OEM Part Numbers: YC3Z12B533AA, DY876

Year Range:
2008-2010

Application:
F-250 / F-550



AP63406

Engine Components

Coolant Pump

OEM Part Number: 7C3Z8B552A

Year Range:
2008-2010

Application:
F-250 / F-550



AP63472

Exhaust Back Pressure (EBP) Tube

OEM Part Number: 8C3Z9F459A

Year Range:
2008-2010

Application:
F-250 / F-550



AP63520

**Indicates products with a core charge.*

6.4L POWER STROKE

Engine Components continued

AP63498



Thermostat Kit

OEM Part Numbers: 8C3Z8575D, RT1212

Year Range:
2008–2010

Application:
F–250 / F–550

AP63504



Water Pump

OEM Part Numbers: 8C3Z8501B, PW482

Notes: Includes mounting gasket.

Year Range:
2008–2010

Application:
F–250 / F–550

AP63468

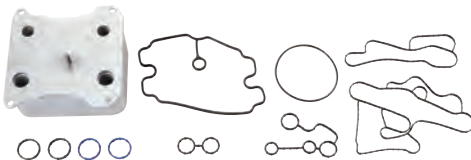

Engine Oil Cooler Kit

OEM Part Number: 8C3Z6A642A

Notes: Includes engine oil cooler and installation kit.

Year Range:
2008–2010

Application:
F–250 / F–550

AP63643 **EXCLUSIVE KITS**

Remanufactured High–Pressure Fuel Pump (HPFP) Kit*

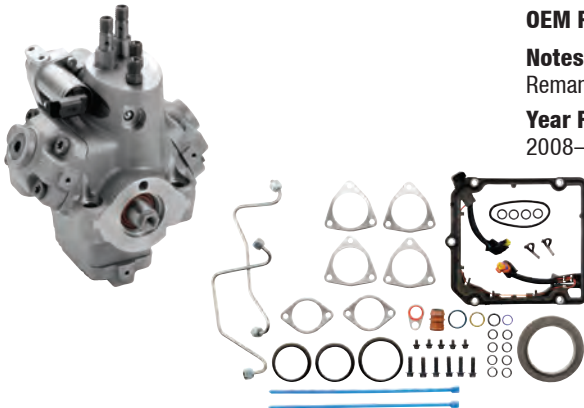

OEM Part Numbers: 8C3Z9A543DRM / B

Notes: Includes pump and installation kit. If pump only is needed see AP63645 Remanufactured High–Pressure Fuel Pump (HPFP).

Year Range:
2008–2010

Application:
F–250 / F–550

AP63645



Remanufactured High–Pressure Fuel Pump (HPFP)*

OEM Part Numbers: 8C3Z9A543DRM / B

Notes: Includes pump only. If installation kit is needed see AP0071 High–Pressure Fuel Pump (HPFP) Installation Kit. If pump and installation kit are needed see AP63643 Remanufactured High–Pressure Fuel Pump (HPFP) Kit.

Year Range:
2008–2010

Application:
F–250 / F–550

*Indicates products with a core charge.

6.4L POWER STROKE

Exhaust Aftertreatment

Diesel Particulate Filter (DPF)

OEM Part Number: 9C3Z5H221B

Notes: Includes installation kit. Pickup truck (wide frame). Not available for sale or use in California.

Year Range:
2008–2010

Application:
F–250 / F–450

AP70000



AP70001

Diesel Particulate Filter (DPF)

OEM Part Number: 9C3Z5H221A

Notes: Includes installation kit. Chassis cab (narrow frame). Not available for sale or use in California.

Year Range:
2008–2010

Application:
F–350 / F–550

EXCLUSIVE KITS

Diesel Particulate Filter Pressure (DPFP) Sensor Fitting

OEM Part Number: 7C3Z9J454A

Notes: Alliant Power has found this fitting to break while changing the DPFP sensor in the DPF.

Year Range:
2008–2010

Application:
F–250 / F–550

AP0164



Sensors

Engine Speed/Position Sensor

OEM Part Numbers: 3C3Z6C315AA, DY985

Notes: Crankshaft Speed/Position.

Year Range:
2008–2010

Application:
F Series

AP63412



Engine Speed/Position Sensor

OEM Part Numbers: 3C3Z12K073AA, 8C3Z12K073A, DU88

Notes: Camshaft Speed/Position.

Year Range:
2008–2010

Application:
F Series

AP63415



Ambient Air Temperature (AAT) Sensor

OEM Part Numbers: AE5Z12A647A, DY1137

Year Range:
2008–2010

Application:
F–250 / F–550

AP63493



6.4L POWER STROKE

Sensors continued

AP63422



Fuel Rail Pressure Sensor

OEM Part Number: 8C3Z9G756A

Year Range:
2008–2010

Application:
F Series

AP63423



Exhaust Back Pressure (EBP) Sensor

OEM Part Numbers: 7E7Z9J460AA, 8C3Z9J460A, DPFE7, DPFE8

Year Range:
2008–2010

Application:
F Series

AP63435



Engine Oil Pressure (EOP) Sensor

OEM Part Numbers: F81Z9278AA, SW5267

Year Range:
2008–2010

Application:
F Series

AP63437

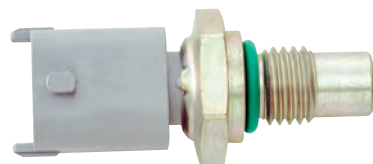

Engine Oil/Coolant/Fuel Temperature (EOT/ECT/FT) Sensor

OEM Part Numbers: 3C3Z10884AA, SW6052

Year Range:
2008–2010

Application:
F Series

AP63463



Intake Manifold Air Temperature (IAT) Sensor

OEM Part Numbers: 8C3Z12A697B, DY1112

Year Range:
2008–2010

Application:
F Series

AP63470



Exhaust Gas Recirculation (EGR) Temperature Sensor–Inlet

OEM Part Number: 8C3Z12B591A

Year Range:
2008–2010

Application:
F Series

6.4L POWER STROKE

continued **Sensors**

Exhaust Gas Recirculation (EGR) Temperature Sensor–Outlet

OEM Part Number: 8C3Z12B591E

Year Range: 2008–2010
Application: F–250 / F–550

AP63471



Diesel Particulate Filter Pressure (DPFP) Sensor

OEM Part Numbers: 8C3Z9J460D, DPFE17

Year Range: 2008–2010
Application: F–250 / F–550

AP63473



Mass Air Flow/Intake Manifold Air Temperature (MAF/IAT) Sensor*

OEM Part Numbers: 7C3Z12B579A, AFLS179

Year Range: 2008–2010
Application: F–250 / F–550

AP63475



Manifold Absolute Pressure (MAP) Sensor

OEM Part Numbers: 8C349F479AA, 8C3Z9F479A, CX2161

Year Range: 2008–2010
Application: F Series

AP63476

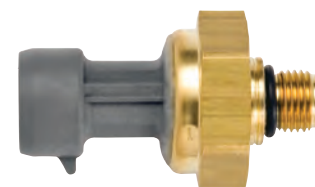

Transmission Fluid Temperature Sensor

OEM Part Number: 9C3Z7H141A

Year Range: 2008–2010
Application: F Series

AP63497



Actuators

Exhaust Gas Recirculation (EGR) Valve

OEM Part Number: 8C3Z9D475D

Year Range: 2008–2010
Application: F Series

AP63456

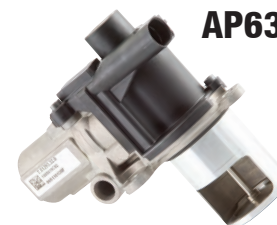

**Indicates products with a core charge.*

6.4L POWER STROKE

Electrical Harness and Repair

AP0021



3 Wire Pigtail

OEM Part Number: 5C3Z12224A

Notes: Fits AP63423 Exhaust Back Pressure (EBP) Sensor.

Year Range:
2008–2010

Application:
F Series

AP0056



2 Wire Pigtail

Notes: Fits AP63437 Engine Oil/Coolant/Fuel Temperature (EOT/ECT/FT) Sensor.

Year Range:
2008–2010

Application:
F Series

EXCLUSIVEPARTS

AP0076



Engine Harness Connector Cover

Year Range:
2008–2010

Application:
F Series

EXCLUSIVEPARTS

AP63515



Injector Harness

OEM Part Number: 8C3Z9D930AA

Notes: Injector harness for the right side.

Year Range:
2008–2010

Application:
F–250 / F–550

AP63516



Injector Harness

OEM Part Number: 8C3Z9D930BA

Notes: Injector harness for the left side.

Year Range:
2008–2010

Application:
F–250 / F–550

Seal and Gasket Kits

AP0027



Injection Line and O-Ring Kit

OEM Part Number: 8C3Z9229A

Year Range:
2008–2010

Application:
F Series

6.4L POWER STROKE

continued **Seal and Gasket Kits**

Engine Oil Cooler Installation Kit

EXCLUSIVEKITS AP0041

Notes: Installation kit only. If engine oil cooler is needed see AP63468 Engine Oil Cooler Kit.

Year Range: 2008–2010
Application: F–250 / F–550



Exhaust Gas Recirculation (EGR) Valve O–Ring

AP0042

OEM Part Number: 8C3Z9D476A

Year Range: 2008–2010
Application: F Series



Head Gasket Kit with Studs** Head Gasket Kit without Studs

EXCLUSIVEKITS AP0064
 AP0065

Year Range: 2008–2010
Application: F Series

Kit Contents:

- 2 Cylinder Head Gaskets
- 2 Exhaust Manifold Gaskets
- 2 Rocker Housing Gaskets
- 2 Valve Cover Gaskets
- 8 Injector Seal Kits with Injection Lines
- 1 Intake Exhaust Gas Recirculation (EGR) Gasket Kit
- 1 Turbo Gasket Kit
- 1 Oil Cooler Gasket Kit
- **Includes Head Stud Kit

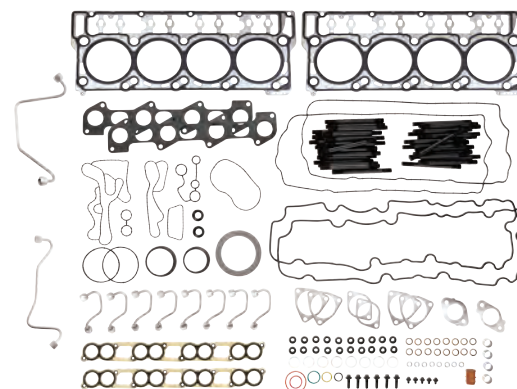

High–Pressure Fuel Pump (HPFP) Installation Kit

EXCLUSIVEKITS AP0071

Notes: Installation kit only. If pump is needed see AP63643 Remanufactured High–Pressure Fuel Pump (HPFP) Kit.

Year Range: 2008–2010
Application: F–250 / F–550



6.4L POWER STROKE

Seal and Gasket Kits continued

AP0134

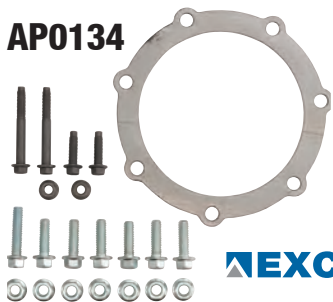

Diesel Particulate Filter (DPF) and Diesel Oxidation Catalyst (DOC) Installation Kit

Notes: Installation kit only. If DPF is needed see AP70000 or AP70001 Diesel Particulate Filter (DPF).

Year Range:
2008–2010

Application:
F Series

EXCLUSIVEKITS

AP63482

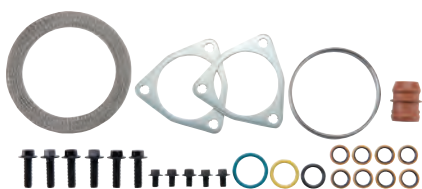

Turbo Installation Kit

OEM Part Number: 8C3Z9T514C

Year Range:
2008–2010

Application:
F–250 / F–550

Engine Accessories

AP63499



Fan Clutch

OEM Part Numbers: 7C3Z8A616F, YB3125

Notes: Without snow plow package.

Year Range:
2008–2010

Application:
F–250 / F–550

AP63518



Fan Clutch

OEM Part Numbers: 8C3Z8A616S, YB3126

Notes: With snow plow package.

Year Range:
2008–2010

Application:
F–250 / F–550

AP63517



Belt Tensioner

OEM Part Numbers: 7C3Z6B209B, BT91

Notes: Accessory belt tensioner.

Year Range:
2008–2010

Application:
F–250 / F–550

AP63519



Belt Tensioner

OEM Part Numbers: 7C3Z6B209E, BT122

Notes: Primary belt tensioner.

Year Range:
2008–2010

Application:
F–250 / F–550

6.4L POWER STROKE

continued **Engine Accessories**

Starter

OEM Part Numbers: 7C3Z11002AA, SA965

Year Range:
2008–2010

Application:
F Series



AP83007

Filters

Horizontal Fuel Conditioning Module (HFCM)

OEM Part Numbers: 8C3Z9G282A, PFB95

Year Range:
2008–2010

Application:
F–250 / F–550



AP63450

Replacement Fuel Pump

OEM Part Number: 9C3Z9G282AC

Notes: Does not include housing.

Year Range:
2007–2010

Application:
F–250 / F–550



PFP58529

Fuel Filter Element Service Kit

OEM Part Numbers: FD4609, FD4617, PFF5550

Notes: Primary and secondary.

Year Range:
2007–2010

Application:
F–250 / F–550



PFF4617

Oil Filter Element Service Kit

OEM Part Number: FL2016

Year Range:
2008–2010

Application:
F Series



PFL2016

Oil Filter Cap

OEM Part Number: 3C3Z6766CA

Year Range:
2008–2010

Application:
F Series



RK31821

RACOR

6.7L POWER STROKE

Modules

AP63525



Glow Plug Control Unit

OEM Part Numbers: BC3Z12B533A / B, DY1261, DY1297, DY1350

Year Range:
2011–2017

Application:
F Series

Fuel System Components

AP63527



Fuel Transfer Pump

OEM Part Numbers: BC3Z9G282E, PFB103

Notes: Engines built BEFORE 05/26/2015.

Year Range:
2012–2015

Application:
F Series

Engine Components

AP63540



Thermostat

OEM Part Numbers: BC3Z8575A / D, RT1205, RT1231

Notes: Main engine thermostat.

Year Range:
2011–2016

Application:
F Series

AP63541



Thermostat

OEM Part Numbers: BC3Z8575B, RT1206

Notes: High temperature right side thermostat.

Year Range:
2011–2016

Application:
F Series

AP63542



Thermostat

OEM Part Numbers: BC3Z8575C, RT1207

Notes: Low temperature left side thermostat.

Year Range:
2011–2016

Application:
F Series

6.7L POWER STROKE

continued **Engine Components**

Water Pump

OEM Part Numbers: BC3Z8501B / C, PW503 / 4

Notes: Water pump only. Fits secondary water pump housing for single or dual alternator.

Year Range:
2011–2017

Application:
F Series

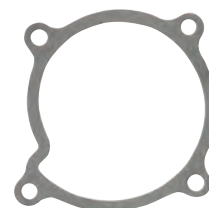

AP63505



Water Pump

OEM Part Numbers: BC3Z8501A, PW502

Notes: Primary water pump.

Year Range:
2011–2016

Application:
F Series



AP63507

Sensors

Ambient Air Temperature (AAT) Sensor

OEM Part Numbers: AU5Z12A647B, DY1160

Year Range:
2011–2016

Application:
F Series



AP63545

Camshaft Position (CMP) Sensor

OEM Part Numbers: BC3Z12K073A, DU92

Year Range:
2011–2017

Application:
F Series



AP63535

6.7L POWER STROKE

Sensors continued

AP63534



Crankshaft Position (CKP) Sensor

OEM Part Numbers: BC3Z6C315A, DY1148

Year Range:
2011–2017

Application:
F Series

AP63528



Diesel Particulate Filter Pressure (DPFP) Sensor

OEM Part Numbers: DC3Z9J460D, DPFE24

Year Range:
2013–2016

Application:
F Series

AP63539



Engine Oil Pressure (EOP) Sensor

OEM Part Numbers: 6U5Z9278D, SW6357

Year Range:
2011–2016

Application:
F Series

AP63526



Exhaust Back Pressure (EBP) Sensor

OEM Part Numbers: BC3Z9J460B / E, DPFE22

Notes: Narrow frame chassis, located in the Diesel Particulate Filter (DPF).

Year Range:
2011–2015

Application:
F-350 / F-550

AP63537



Exhaust Back Pressure/Diesel Particulate Filter Pressure (EBP/DPFP) Sensor

OEM Part Numbers: BC3Z9J460D, DPFE21

Notes: Wide frame chassis, located in the Diesel Particulate Filter (DPF).

Year Range:
2011–2016

Application:
F Series

6.7L POWER STROKE

continued **Sensors**

Exhaust Gas Recirculation (EGR) Pressure Sensor

OEM Part Numbers: BC3Z9J460C, DPFE20

Year Range:
2011–2017

Application:
F Series

AP63529



Intake Air/Charge Air Cooler Temperature (IAT/CACT) Sensor

OEM Part Numbers: 4R8Z12A697A, DY1146

Year Range:
2011–2017

Application:
F Series

AP63544



Manifold Absolute Pressure (MAP) Sensor

OEM Part Numbers: BC3Z9F479B, CX2432

Year Range:
2011–2017

Application:
F Series

AP63543



Mass Air Flow (MAF) Sensor*

OEM Part Numbers: BC3Z12B579A, AFLS166

Year Range:
2011–2016

Application:
F Series

AP63524



Reductant Fluid Level Sensor

OEM Part Number: BC3Z5J225L

Year Range:
2011–2016

Application:
F-250 / F-550

AP63521



Transmission Fluid Temperature Sensor

OEM Part Number: BC3Z7H141A

Year Range:
2011–2015

Application:
F Series

AP63497



**Indicates products with a core charge.*

6.7L POWER STROKE

Actuators

AP63522



Exhaust Gas Recirculation (EGR) Valve

OEM Part Numbers: BC3Z9D475C, CX2404

Notes: Used on narrow frame cab chassis models.

Year Range:
2011–2016

Application:
F–350 / F–550

AP63523



Exhaust Gas Recirculation (EGR) Valve

OEM Part Numbers: BC3Z9D475D, CX2405

Notes: Used on wide frame pickup chassis models.

Year Range:
2011–2016

Application:
F–250 / F–350

AP91000



Turbocharger Vane Actuator

OEM Part Numbers: 5C3Z6F089A / BA, 792593–0001

Year Range:
2011–2017

Application:
F Series

Electrical Harness and Repair

AP0068



2 Wire Pigtail

Notes: Fits AP91000 Turbocharger Vane Actuator.

Year Range:
2011–2017

Application:
F–250 / F–550

EXCLUSIVE PARTS

Seal and Gasket Kits

AP0087

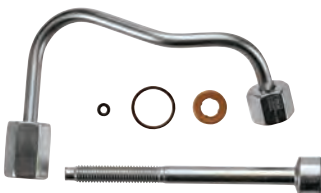

Injection Line and O-Ring Kit

OEM Part Numbers: BC3Z9229A, CM5191

Notes: For cylinders 1, 2, 7, 8.

Year Range:
2011–2017

Application:
F Series

6.7L POWER STROKE

continued **Seal and Gasket Kits**

Injection Line and O-Ring Kit

OEM Part Numbers: BC3Z9229B, CM5192

Notes: For cylinders 3, 4, 5, 6.

Year Range:
2011–2017

Application:
F Series



Head Gasket Kit with Studs** Head Gasket Kit without Studs

Year Range:
2011–2014

Application:
F Series

Kit Contents:

- 2 Cylinder Head Gaskets
- 2 Exhaust Manifold Gaskets
- 2 Valve Cover Gaskets
- 8 Injection Line and O-Ring Kits
- 1 Turbo Mounting Kit
- 1 Fuel Rail Supply Tube
- **Includes Head Stud Kit



EXCLUSIVEKITS AP0152 AP0153

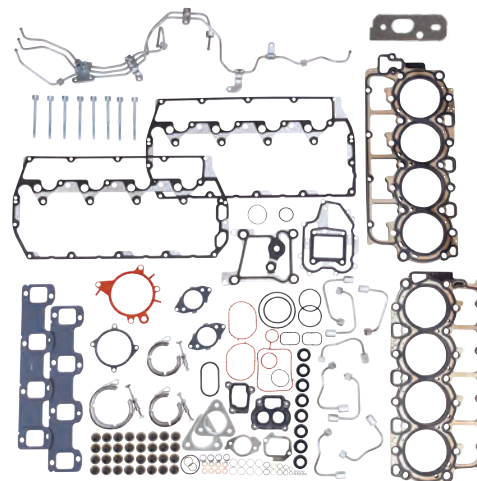

Turbocharger Installation Kit

Year Range:
2011–2014

Application:
F Series

EXCLUSIVEKITS AP0156



6.7L POWER STROKE

Seal and Gasket Kits continued

AP0157



Fuel Injection Pump Installation Kit

Year Range:
2011–2014

Application:
F Series

EXCLUSIVEKITS

Engine Accessories

AP83009



Alternator*

OEM Part Numbers: BC3Z10346A / D, GL8754, GL992

Notes: Bottom alternator on dual alternator chassis.

Year Range:
2011–2016

Application:
F Series

AP83010



Alternator*

OEM Part Numbers: BC3Z10346B, GL993

Notes: Single alternator chassis.

Year Range:
2011–2016

Application:
F Series

AP83011



Alternator*

OEM Part Numbers: BC3Z10346C, GL994

Notes: Top alternator on dual alternator chassis.

Year Range:
2011–2016

Application:
F Series

AP63538



Belt Tensioner

OEM Part Numbers: BC3Z6B209A / B, BT131

Year Range:
2011–2017

Application:
F Series

**Indicates products with a core charge.*

6.7L POWER STROKE

continued **Engine Accessories**

Vacuum Pump

OEM Part Numbers: BC3Z2A451A / B, BRPV-8 / 22

Year Range:
2011–2016

Application:
F Series

AP63725



Starter*

OEM Part Numbers: BC3Z11002A, SA1004

Year Range:
2011–2017

Application:
F Series

AP83008



Filters

Fuel Filter Element Service Kit

OEM Part Numbers: BC3Z9N184B, FD4615

Notes: Primary and secondary.

Year Range:
2011–2016

Application:
F-250 / F-550

AP61004





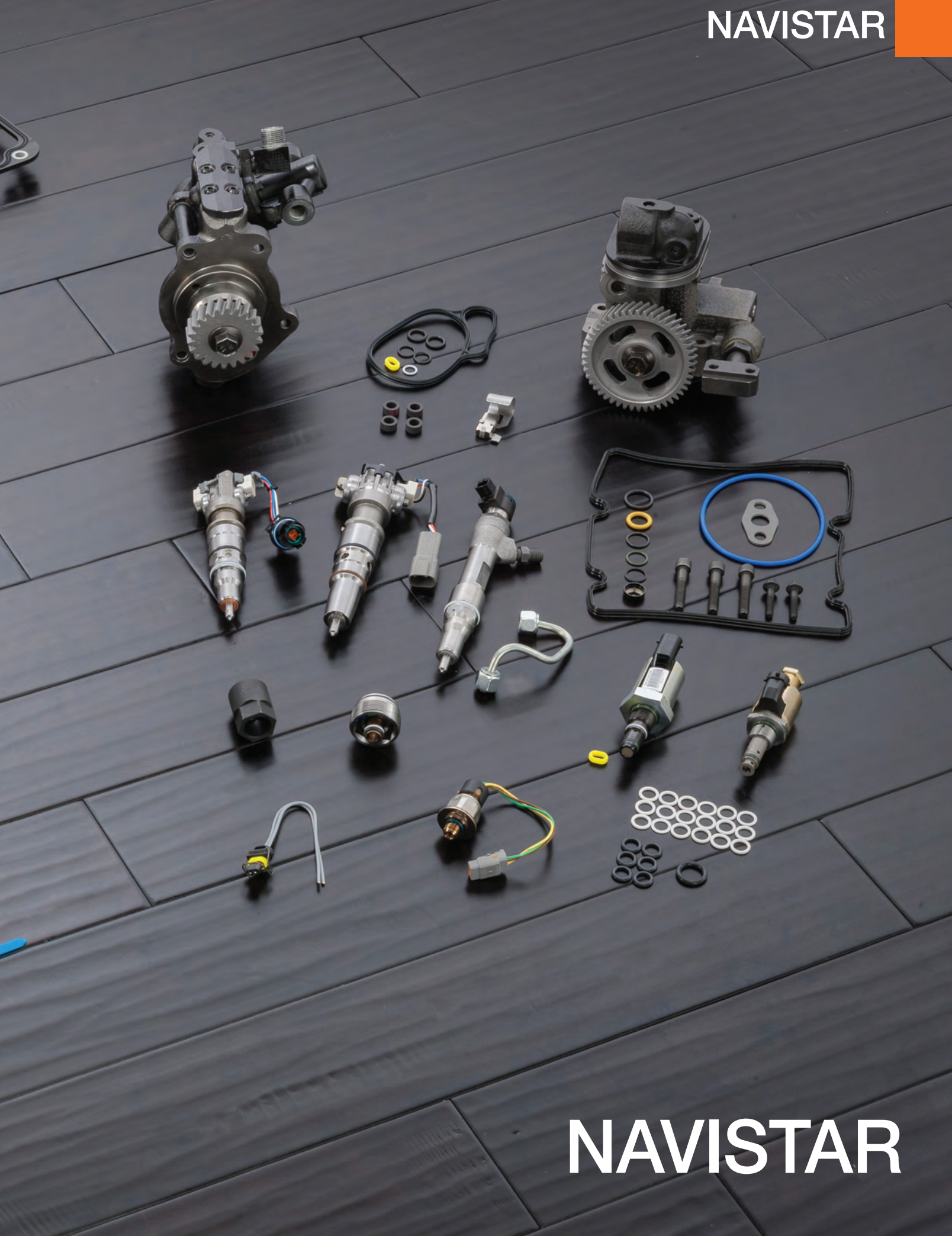



New OEM HEUI® injectors available exclusively through Alliant Power

- ▶ Brand new original equipment HEUI injectors
- ▶ Complete 1994 to 2003 Navistar mid-range coverage
- ▶ Available exclusively through Alliant Power
- ▶ 24-month, unlimited mileage warranty in Navistar applications



Injectors

HEUI Injector*

OEM Part Numbers: 1816187C3, 1818259C2, 1821752C1, 1821836C3, 1822800C95, 1822801C91

Year Range:	Application:	ESN Range:
1994–1996	T444E	500 to 460,194

HEUI Injector*

OEM Part Numbers: 1822803C1, 1823561C1, 1824582C94, 1824583C97, 1825125C1, 1825126C1, 1833647C91

Notes: Prime (Split Shot) Injector.

Year Range:	Application:	ESN Range:
1997–1999	T444E	460,195 to 843,989

HEUI Injector*

OEM Part Numbers: 1824474C2, 1822890C1, 1824472C1, 1824473C2, 1824455C94, 1824456C96

Year Range:	Application:
1994–1996	T444E: High Output 210 HP (HT) to 230 HP

HEUI Injector*

OEM Part Numbers: 1823751C91, 1831487C92, 1831488C1, 1831489C1, 1831550C1, 1831551C1

Notes: Prime (Split Shot) Injector. Recommend replacing AD Injector in #8 cylinder location with AE Injector to eliminate “cackle”. This became standard production in 2002.

Year Range:	Application:	ESN Range:
1999–2003	T444E	843,990 to 5,999,999

HEUI Injector*

OEM Part Numbers: 1833639C1, 1833640C1, 1833644C1, 1833645C1, 1833646C92

Notes: Long Lead (LL or blue harness connector) Injector. Used in #8 cylinder location to eliminate “cackle.”

Year Range:	Application:	ESN Range:
2002–2003	T444E	1,313,828 to 5,999,999



AP63800AA



AP63801AB

AP63802AC

AP63803AD

AP63804AE

EXCLUSIVE PARTS

* Indicates products with a core charge.

T444E

Fuel System Components

APM61067



Fuel Transfer Pump—Mechanical

OEM Part Numbers: 1824415C93, 1826794C93

Notes: Includes two banjo gaskets.

Year Range:
1994–2003

Application:
T444E

AP63409



Fuel Filter Heater Element

OEM Part Number: 1825186C91

Year Range:
1994–1998

Application:
T444E

AP63410



Fuel Filter Heater Element

OEM Part Number: 1831196C92

Year Range:
1999–2003

Application:
T444E

Engine Components

AP63411



HEUI Injector Sleeve—Brass

OEM Part Number: 1814376C1

Year Range:
1994–2003

Application:
T444E

AP63452



Engine Oil Cooler

OEM Part Number: 1815904C2

Notes: Requires AP0004 Engine Oil Cooler O-ring and Gasket Kit for installation.

Year Range:
1994–2003

Application:
T444E

AP63581



Water Pump

OEM Part Numbers: 1831676C92, 1889249C91

Notes: Includes mounting gasket and plugs.

Year Range:
1994–2003

Application:
T444E

Remanufactured High-Pressure Oil Pump

OEM Part Numbers: 1825247C91, 1825260C91, 1825271C93, 2503701C91

Notes: Includes mounting gasket.

Year Range: See ESN	Application: T444E	ESN Range: 500 to 216,543
-------------------------------	------------------------------	-------------------------------------



HP004X

Remanufactured High-Pressure Oil Pump

OEM Part Numbers: 1825248C91, 1825259C91, 2503703C91

Notes: Includes mounting gasket.

Year Range: See ESN	Application: T444E	ESN Range: 216,544 to 661,894
-------------------------------	------------------------------	---



HP005X

Remanufactured High-Pressure Oil Pump

OEM Part Numbers: 1830857C91, 2503704C91

Notes: Includes mounting gasket.

Year Range: See ESN	Application: T444E	ESN Range: 661,895 to 843,989
-------------------------------	------------------------------	---



HP007X

Remanufactured High-Pressure Oil Pump

OEM Part Numbers: 1831449C91, 2589446C91

Notes: Includes mounting gasket.

Year Range: See ESN	Application: T444E	ESN Range: 843,990 to End
-------------------------------	------------------------------	-------------------------------------



HP008X

Sensors

Camshaft Position (CMP) Sensor

OEM Part Number: 1876736C91

Year Range: 1994–1996	Application: T444E
---------------------------------	------------------------------



AP63491

T444E

Sensors continued

AP63400



Camshaft Position (CMP) Sensor

OEM Part Numbers: 1825899C93, 1876735C91

Year Range:
1997–2003

Application:
T444E

AP63403

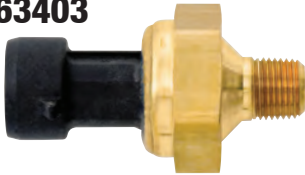

Exhaust Back Pressure (EBP) Sensor

OEM Part Number: 1850353C1

Year Range:
1997–2002

Application:
T444E

AP63418



Injection Control Pressure (ICP) Sensor

OEM Part Number: 1807329C92

Year Range:
1994–2003

Application:
T444E

Actuators

AP63401



Injection Pressure Regulator (IPR) Valve

OEM Part Numbers: 1824982C91, 1833798C91, 1841279C91

Notes: With edge filter.

Year Range:
See ESN

Application:
T444E

ESN Range:
500 to 216,543

AP63402



Injection Pressure Regulator (IPR) Valve

OEM Part Numbers: 1829856C91, 1836412C91, 1841086C91, 1841217C91

Notes: Without edge filter.

Year Range:
See ESN

Application:
T444E

ESN Range:
216,544 to End

AP63405



Glow Plug Relay

OEM Part Numbers: 1826634C94, 1831646C1

Year Range:
1994–2003

Application:
T444E

Electrical Harness and Repair

Valve Cover Harness Connector Repair Kit

Notes: Repairs AP0016 Valve Cover Gasket Connector Pigtail.

Year Range:
1998–2003

Application:
T444E

EXCLUSIVEKITS AP0009



Valve Cover Harness Connector Repair Kit

Notes: Repairs AP0015 Valve Cover Gasket Connector Pigtail.

Year Range:
1994–1997

Application:
T444E

EXCLUSIVEKITS AP0010



Valve Cover Gasket Connector Pigtail

EXCLUSIVEPARTS

AP0015

Year Range:
1994–1997

Application:
T444E



Valve Cover Gasket Connector Pigtail

EXCLUSIVEPARTS

AP0016

Year Range:
1998–2003

Application:
T444E

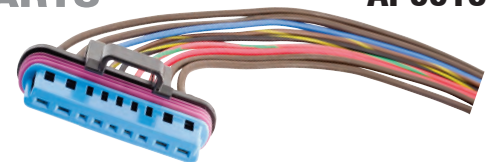

3 Wire Pigtail

Notes: Fits AP63418 Injection Control Pressure (ICP) Sensor and AP63403 Exhaust Back Pressure (EBP) Sensor.

Year Range:
1994–2003

Application:
T444E

AP0021



2 Wire Pigtail

Notes: Fits AP63401 and AP63402 Injection Pressure Regulator (IPR) Valves and all HEUI A Injectors.

Year Range:
1994–2003

Application:
T444E

AP0068



EXCLUSIVEPARTS

T444E

Electrical Harness and Repair continued

AP63413

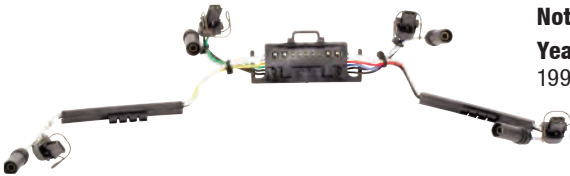

Internal Injector Harness

OEM Part Number: 1830844C93

Notes: Use with AP0014 Valve Cover Gasket Kit.

Year Range:
1998–2003

Application:
T444E

AP63414



Internal Injector Harness

OEM Part Number: 1815923C92

Notes: Use with AP0013 Valve Cover Gasket Kit.

Year Range:
1994–1997

Application:
T444E

Seal and Gasket Kits

AP0001



HEUI Injector Seal Kit

OEM Part Number: 1833564C92

Year Range:
1994–2003

Application:
T444E

AP0003

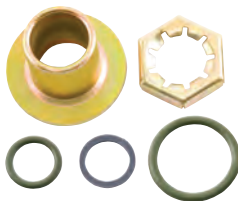

Injection Pressure Regulator (IPR) Valve Seal Kit

OEM Part Number: 1825806C91

Year Range:
1994–2003

Application:
T444E

AP0004 **EXCLUSIVEKITS**

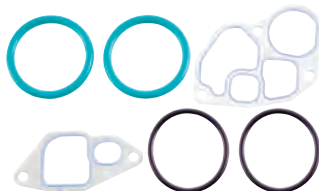

Engine Oil Cooler O-ring and Gasket Kit

Year Range:
1994–2003

Application:
T444E

AP0011 **EXCLUSIVEKITS**

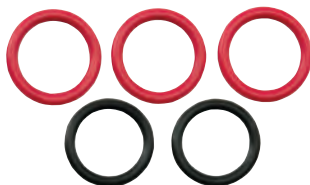

High-Pressure Oil Pump Seal Kit

Year Range:
1994–2003

Application:
T444E

Valve Cover Gasket Kit

OEM Part Number: 1818350C2

Notes: Use with AP63414 Internal Injector Harness. Package of two.

Year Range: 1994–1997
Application: T444E

AP0013

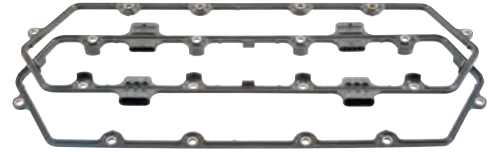

Valve Cover Gasket Kit

OEM Part Number: 1826703C1

Notes: Use with AP63413 Internal Injector Harness. Package of two.

Year Range: 1998–2003
Application: T444E

AP0014

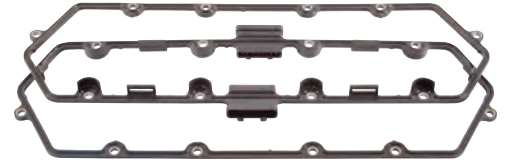

Turbo Installation Kit

OEM Part Number: 1831658C91

Year Range: 1999–2003
Application: T444E

AP63461

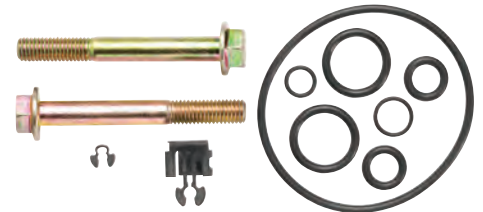

Filters

Fuel Filter Element Service Kit

OEM Part Number: 1822631C91

Year Range: 1994–2003
Application: T444E

PFF4595



Fuel Filter Top Cover

Year Range: 1994–2003
Application: T444E

RACOR

RK31019





NEW

Injector Coils



NEW

Connector



NEW

Spool Valve

Alliant Power partners with PurePower Technologies®!

PurePower's industry leading remanufactured G2.8 injectors now available to the aftermarket through Alliant Power.

- ▶ Remanufactured by PurePower Technologies
 - 100% new coil and harness assemblies with vented slot technology
 - 100% new spool valve and connector
 - 24-month, unlimited mileage warranty in Navistar applications
- ▶ Brand new injectors also available



VT365, VT275, MAXXFORCE 5

Injectors

PPT Remanufactured G2.8 Injector* PPT New G2.8 Injector*

OEM Part Numbers: 1843089C95, 1843481C95, 1845879C91, 1878281C92, 1878282C92, 6901-PP, 6918-PP

Year Range: 2002½-2003
Application: VT365

PPT Remanufactured G2.8 Injector* PPT New G2.8 Injector*

OEM Part Numbers: 1844751C2, 1845150C92, 1846692C2, 1877748C1, 1878284C91, 1878285C91, 1879998C91, 6902-PP, 6919-PP

Year Range: 2004-2006
2006
2007-2010
Application: VT365
VT275
MaxxForce 5



**AP60900
AP60800**

**AP60901
AP60801**

purePOWER
TECHNOLOGIES

Fuel System Components

Fuel Filter Heater Element

OEM Part Number: 1831196C92

Year Range: 2003-2007
Application: VT365



AP63410

Engine Components

Oil Cooler/Exhaust Gas Recirculation (EGR) Cooler Kit*

Notes: Includes AP63451 Engine Oil Cooler Kit and AP63446 Exhaust Gas Recirculation (EGR) Cooler Kit. Core is required only on the Exhaust Gas Recirculation (EGR) Cooler.

Year Range: 2004-2007
Application: VT365

EXCLUSIVEKITS AP63445

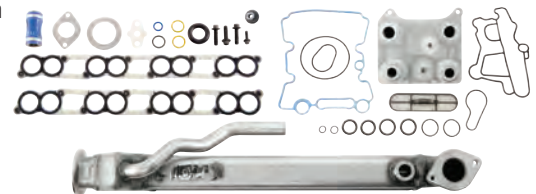

*Indicates products with a core charge.

VT365, VT275, MAXXFORCE 5

Engine Components continued

AP63446 **NEXCLUSIVEKITS**



Exhaust Gas Recirculation (EGR) Cooler Kit*

OEM Part Number: 1845145C99

Notes: Includes AP63447 Exhaust Gas Recirculation (EGR) Cooler Intake Gasket Kit.

Year Range:
2004–2007

Application:
VT365

AP63451

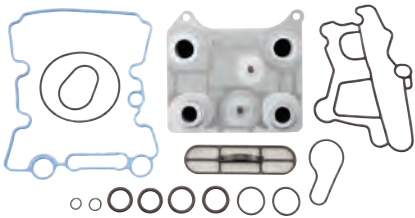

Engine Oil Cooler Kit

OEM Part Number: 1886511C93

Notes: Includes AP0039 Engine Oil Cooler Gasket Kit.

Year Range:
2003–2007
2006
2007–2010

Application:
VT365
VT275
MaxxForce 5

AP63583

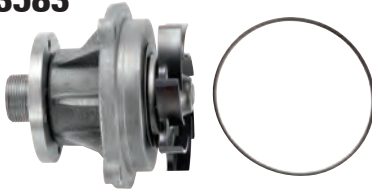

Water Pump

OEM Part Number: 1845002C91

Notes: Includes mounting gasket.

Year Range:
2002–2007

Application:
VT365

AP63503

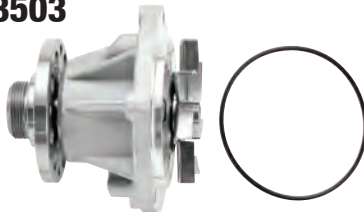

Water Pump

OEM Part Number: 5010118R91

Notes: Includes mounting gasket.

Year Range:
2006
2007–2010

Application:
VT275
MaxxForce 5

AP63661

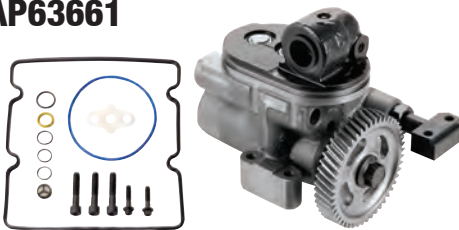

Remanufactured High-Pressure Oil Pump*

OEM Part Numbers: 1882919C92, 1878865C91, 1842410C91, 1847084C91, 4307329R91

Notes: Includes seal kit.

Year Range:
2004½–2007

Application:
VT365

VT365, VT275, MAXXFORCE 5

continued **Engine Components**

Remanufactured High-Pressure Oil Pump*

OEM Part Numbers: 4307325R91, 1884357C92

Notes: Includes seal kit.

Year Range:
2006

Application:
VT275

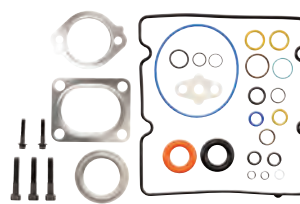

AP63662

Remanufactured High-Pressure Oil Pump*

OEM Part Numbers: 4307327R91, 1880313C94

Notes: Includes seal kit.

Year Range:
2007–2010

Application:
MaxxForce 5

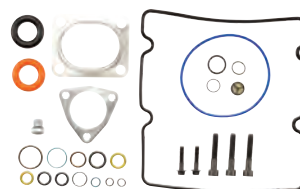

AP63663

Remanufactured High-Pressure Oil Pump

OEM Part Numbers: 1838828C91, 1843045C92, 2591022C91

Notes: Includes seal kit.

Year Range:
2002–2004

Application:
VT365



HP032X

Sensors

Engine Speed/Position Sensor

OEM Part Number: 1828345C91

Notes: Crankshaft Speed/Position.

Year Range:
2003–2007
2006
2007–2010

Application:
VT365
VT275
MaxxForce 5



AP63412

**Indicates products with a core charge.*

VT365, VT275, MAXXFORCE 5

Sensors continued

AP63415



Engine Speed/Position Sensor

OEM Part Number: 1835985C92

Notes: Camshaft Speed/Position.

Year Range:	Application:
2003–2007	VT365
2006	VT275
2007–2010	MaxxForce 5

AP63435



Engine Oil Pressure (EOP) Sensor

OEM Part Number: 1831259C91

Year Range:	Application:
2006	VT275
2007–2010	MaxxForce 5

AP63474

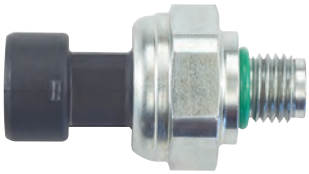

Engine Oil Pressure (EOP) Sensor

OEM Part Numbers: 1839415C91, 1837802C1, 1839832C1, 1872556C91

Notes: AP0021 3 Wire Pigtail can be used to repair the harness connector.

Year Range:	Application:
2004–2007	VT365

AP63437

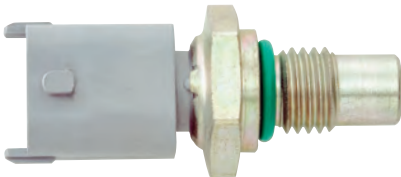

Engine Oil/Coolant/Fuel Temperature (EOT/ECT/FT) Sensor

OEM Part Number: 1836537C91

Year Range:	Application:
2003–2007	VT365
2006	VT275
2007–2010	MaxxForce 5

AP63403

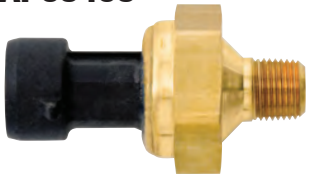

Exhaust Back Pressure (EBP) Sensor

OEM Part Number: 1850353C1

Year Range:	Application:
2003–2004	VT365

AP63408



Exhaust Back Pressure (EBP) Sensor

OEM Part Number: 1850352C2

Year Range:	Application:
2005–2007	VT365

VT365, VT275, MAXXFORCE 5

continued **Sensors**

Exhaust Back Pressure (EBP) Sensor

OEM Part Number: 1846480C2

Year Range:
2007–2010

Application:
MaxxForce 5

AP63423



Injection Control Pressure (ICP) Sensor

OEM Part Number: 1845274C92

Notes: Mounts below turbo.

Year Range:
2003–2004

Application:
VT365

AP63407



Injection Control Pressure (ICP) Sensor

OEM Part Numbers: 1845428C92, 1845427C2

Notes: Mounts on passenger side valve cover.

Year Range:
2004–2007
2006
2007–2010

Application:
VT365
VT275
MaxxForce 5

AP63460



Intake Manifold Air Temperature (IAT) Sensor

OEM Part Number: 1836539C91

Year Range:
2003–2007
2006

Application:
VT365
VT275

AP63462



Intake Manifold Air Temperature (IAT) Sensor

OEM Part Number: 1875838C91

Year Range:
2007–2010

Application:
MaxxForce 5

AP63463



Manifold Absolute Pressure (MAP) Sensor

OEM Part Number: 1846481C92

Year Range:
2007–2010

Application:
MaxxForce 5

AP63476



VT365, VT275, MAXXFORCE 5

Actuators

AP63416



Injection Pressure Regulator (IPR) Valve

OEM Part Number: 1839437C95

Notes: Without edge filter.

Year Range:
2003–2004

Application:
VT365

AP63417



Injection Pressure Regulator (IPR) Valve

OEM Part Number: 1846057C1

Notes: With edge filter.

Year Range:
2005–2007
2006
2007–2010

Application:
VT365
VT275
MaxxForce 5

AP63438R



Remanufactured Exhaust Gas Recirculation (EGR) Valve*

OEM Part Number: 1846491C91, 5010682R91

Year Range:
2002½–2003

Application:
VT365

AP63459

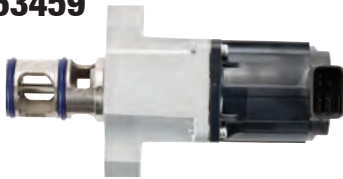

Exhaust Gas Recirculation (EGR) Valve

OEM Part Number: 1846296C91

Year Range:
2004–2006

Application:
VT365

AP63479



Glow Plug Relay

OEM Part Number: 1840903C91

Year Range:
2003–2007
2006

Application:
VT365
VT275

*Indicates products with a core charge.

VT365, VT275, MAXXFORCE 5

Electrical Harness and Repair

3 Wire Pigtail

AP0021

Notes: Fits AP63407 and AP63460 Injection Control Pressure (ICP) Sensors, AP63403, AP63408, and AP63423 Exhaust Back Pressure (EBP) Sensors, AP63474 Engine Oil Pressure (EOP) Sensor, as well as AP63476 Manifold Absolute Pressure (MAP) Sensor.

Year Range:	Application:
2003–2007	VT365
2006	VT275
2007–2010	MaxxForce 5



2 Wire Pigtail

EXCLUSIVE PARTS AP0056

Notes: Fits AP63437 Engine Oil/Coolant/Fuel Temperature (EOT/ECT/FT) Sensor and AP63462 Intake Manifold Air Temperature (IAT) Sensor.

Year Range:	Application:
2003–2007	VT365
2006	VT275
2007–2010	MaxxForce 5



Injector Harness Connector

EXCLUSIVE PARTS AP0030

Year Range:	Application:
2003–2007	VT365
2006	VT275
2007–2010	MaxxForce 5



G2.8 Injector Connector

EXCLUSIVE PARTS AP0040

Notes: See Technical Bulletin APTB 03/14 for installation instructions.

Year Range:	Application:
2003–2007	VT365
2006	VT275
2007–2010	MaxxForce 5



Fuel Injection Control Module (FICM) Connector

EXCLUSIVE PARTS AP0018

Notes: Field data shows identification marks 1456315–6, 1437287–7, or X–3.

Year Range:	Application:
2003–2007	VT365
2006	VT275

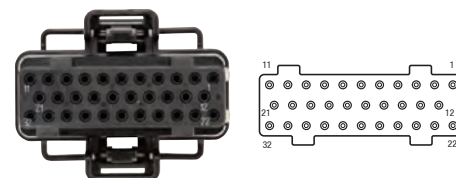

Fuel Injection Control Module (FICM) Connector

EXCLUSIVE PARTS AP0019

Notes: Field data shows identification marks 1456315–2, 1437287–6, or X–2.

Year Range:	Application:
2003–2007	VT365
2006	VT275

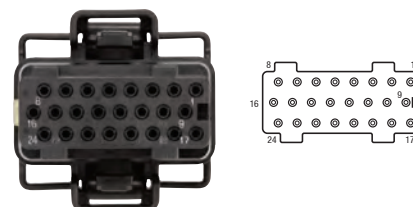

VT365, VT275, MAXXFORCE 5

Electrical Harness and Repair continued

AP0020

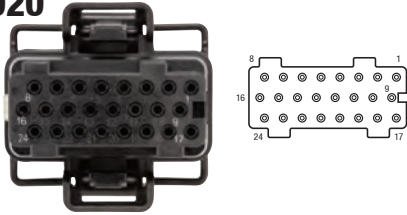

Fuel Injection Control Module (FICM) Connector

Notes: Field data shows identification marks 1456316-1, 1437287-5, or X-1.

Year Range:
2003-2007
2006

Application:
VT365
VT275

EXCLUSIVEPARTS

AP0068



2 Wire Pigtail

Notes: Fits AP63416 and AP63417 Injection Pressure Regulator (IPR) Valves and AP91000 Turbocharger Vane Actuator.

Year Range:
2003-2007
2006
2007-2010

Application:
VT365
VT275
MaxxForce 5

Seal and Gasket Kits

AP0002

EXCLUSIVEKITS

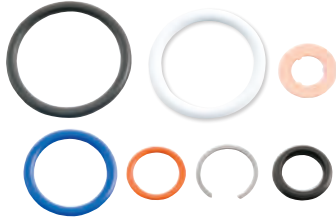

G2.8 Injector Seal Kit

OEM Part Number: 1843682C91

Notes: Includes high-pressure oil seal.

Year Range:
2002½-2007
2006
2007-2010

Application:
VT365
VT275
MaxxForce 5

AP0005



Exhaust Gas Recirculation (EGR) Valve O-ring Kit

OEM Part Number: 1840778C91

Year Range:
2003-2004

Application:
VT365

AP0023

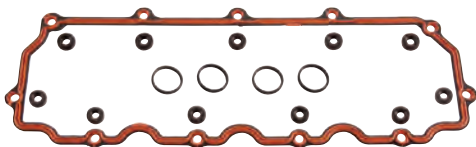

Valve Cover Gasket

OEM Part Number: 1838250C1

Year Range:
2003-2007

Application:
VT365

VT365, VT275, MAXXFORCE 5

continued Seal and Gasket Kits

Stand Pipe and Front Port Plug Seal Kit

Notes: Reseals one side.

Year Range:	Application:
2003–2007	VT365
2006	VT275
2007–2010	MaxxForce 5

EXCLUSIVEKITS AP0028



Injection Pressure Regulator (IPR) Valve Seal Kit

OEM Part Number: 1888696C93

Year Range:	Application:
2003–2007	VT365
2006	VT275
2007–2010	MaxxForce 5

AP0035



Engine Oil Cooler Gasket Kit

Year Range:	Application:
2003–2007	VT365
2006	VT275
2007–2010	MaxxForce 5

EXCLUSIVEKITS AP0039

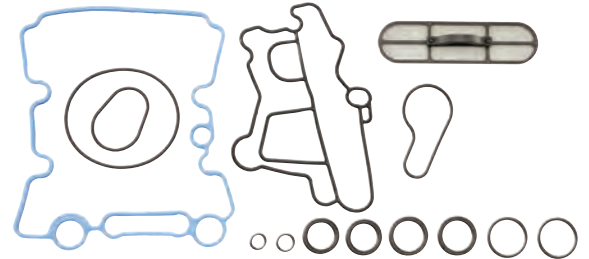

Exhaust Gas Recirculation (EGR) Valve Seal Kit

OEM Part Number: 1858088C92

Year Range:	Application:
2004–2006	VT365

AP0057



High-Pressure Oil Rail Seal Kit

Notes: AP0069 High-Pressure Oil Rail Socket required for installation.

Year Range:	Application:
2003–2007	VT365
2006	VT275
2007–2010	MaxxForce 5

EXCLUSIVEKITS AP0070



VT365, VT275, MAXXFORCE 5

Seal and Gasket Kits continued

AP63447 **EXCLUSIVEKITS** Exhaust Gas Recirculation (EGR) Cooler Intake Gasket Kit



OEM Part Number: 1840702C97

Year Range:
2003–2007

Application:
VT365

AP63481



Turbo Installation Kit

OEM Part Number: 1840053C97

Year Range:
2004–2007

Application:
VT365

Filters

PFF31795



Fuel Filter Housing Cap

OEM Part Number: 1843057C92

Year Range:
2006
2007–2010

Application:
VT275
MaxxForce 5

PFF4616



Fuel Filter Element Service Kit

Notes: Primary and secondary.

Year Range:
2006
2007–2010

Application:
VT275
MaxxForce 5

PFL2016



Oil Filter Element Service Kit

Year Range:
2003–2007

Application:
VT365

VT365, VT275, MAXXFORCE 5

continued **Filters**

Oil Filter Cap

OEM Part Number: 1840754C91

Year Range:
2003–2007
2006
2007–2010

Application:
VT365
VT275
MaxxForce 5

RACOR.



RK31821



Fuel Filter Element Service Kit

Year Range:
2003–2007

Application:
VT365

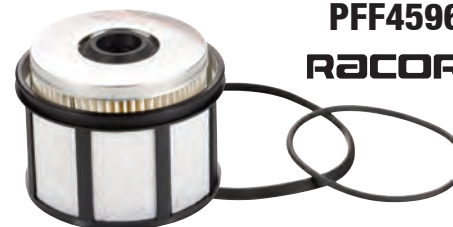

PFF4596

RACOR.

Fuel Filter Top Cover

Year Range:
2003–2007

Application:
VT365



RK31449

RACOR.

Please visit AlliantPower.com for
up-to-date New Product Announcements,
Sales Flyers and Technical Bulletins.





Alliant Power partners with PurePower Technologies®!

PurePower's industry leading remanufactured piezo injectors now available to the aftermarket through Alliant Power.

- ▶ Remanufactured by PurePower Technologies
 - Piezos are 100% tested for performance and replaced with new when necessary
 - 24-month, unlimited mileage warranty in Navistar applications
- ▶ Brand new injectors also available



MAXXFORCE 7

Injectors

PPT Remanufactured Piezo Injector*
PPT New Piezo Injector*

OEM Part Numbers: 1873422C93, 4307381R91, 4307369R91, 5010359R93, 6903-PP, 6920-PP

Notes: Pre-2010 emission engines. Includes injection line.

Year Range: 2007-2010	Application: MaxxForce 7	ESN Range: 434,544 to 5,300,001
---------------------------------	------------------------------------	---



AP64900
AP64800

PPT Remanufactured Piezo Injector*
PPT New Piezo Injector*

OEM Part Numbers: 1883110C1, 1883111C92, 1899239C92, 5010889R91, 6904-PP, 6921-PP

Notes: Post 2010 emission engines. Includes injection line.

Year Range: 2010-2016	Application: MaxxForce 7	ESN Range: 5,300,002 to End
---------------------------------	------------------------------------	---------------------------------------

AP64901
AP64801



Engine Components

Engine Oil Cooler Kit

OEM Part Number: 1855839C95

Notes: Includes engine oil cooler and installation kit.

Year Range: 2007-2010	Application: MaxxForce 7
---------------------------------	------------------------------------

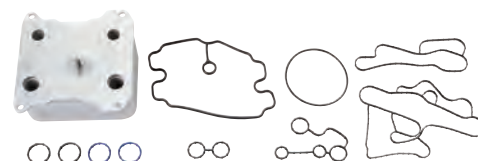

AP63468

**Indicates products with a core charge.*

MAXXFORCE 7

Engine Components continued

AP63644



Remanufactured High-Pressure Fuel Pump (HPFP) Kit*

OEM Part Numbers: 4307291R91, 1876529C98, 1855860C94

Notes: Pre-2010 emission engines. Includes pump and installation kit. See Technical Bulletin APTB 09/16 for connector spacer removal and zip tie installation.

Year Range:
2007-2010

Application:
MaxxForce 7

EXCLUSIVEKITS

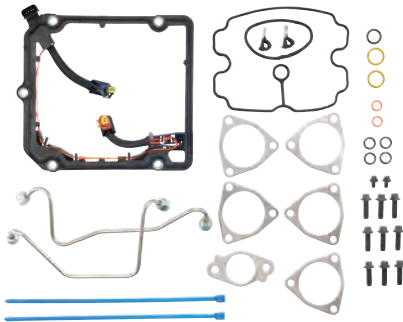

AP63642



Remanufactured High-Pressure Fuel Pump (HPFP) Kit*

OEM Part Numbers: 7080839C92, 5010756R92

Notes: Post 2010 emission engines. Includes pump and installation kit. See Technical Bulletin APTB 09/16 for connector spacer removal and zip tie installation.

Year Range:
2010-2016

Application:
MaxxForce 7

EXCLUSIVEKITS

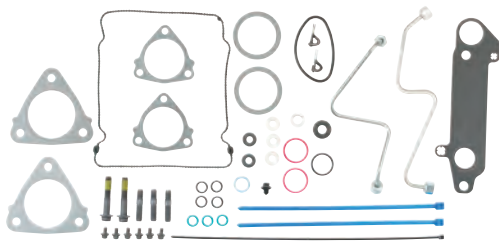

AP63480



Fuel Supply Hose

OEM Part Number: 7081021C1

Notes: Install on engines built BEFORE 04/06/2011.

Year Range:
2010-2016

Application:
MaxxForce 7

* Indicates products with a core charge.

MAXXFORCE 7

Sensors

Engine Speed/Position Sensor

OEM Part Number: 1828345C91

Notes: Crankshaft Speed/Position.

Year Range:
2007–2016

Application:
MaxxForce 7



AP63412

Engine Speed/Position Sensor

OEM Part Number: 1835985C92

Notes: Camshaft Speed/Position.

Year Range:
2007–2016

Application:
MaxxForce 7



AP63415

Fuel Rail Pressure Sensor

OEM Part Number: 1873400C92

Year Range:
2007–2016

Application:
MaxxForce 7



AP63422

Exhaust Back Pressure (EBP) Sensor

OEM Part Numbers: 1846480C2, 1847913C91

Year Range:
2007–2010

Application:
MaxxForce 7



AP63423

Engine Oil Pressure (EOP) Sensor

OEM Part Numbers: 1839415C91, 1837802C1, 1839832C1, 1872556C91

Notes: AP0021 3 Wire Pigtail can be used to repair the harness connector.

Year Range:
2007–2016

Application:
MaxxForce 7

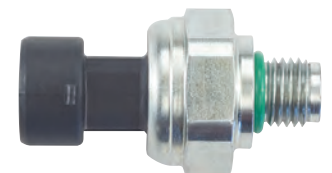

AP63474

Engine Oil/Coolant/Fuel Temperature (EOT/ECT/FT) Sensor

OEM Part Number: 1836537C91

Year Range:
2007–2016

Application:
MaxxForce 7

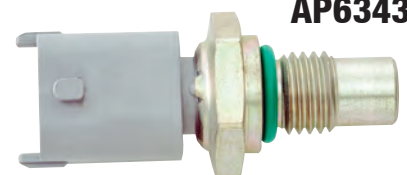

AP63437

Intake Manifold Air Temperature (IAT) Sensor

OEM Part Number: 1875838C91

Year Range:
2007–2009

Application:
MaxxForce 7



AP63463

MAXXFORCE 7

Sensors continued

AP63470

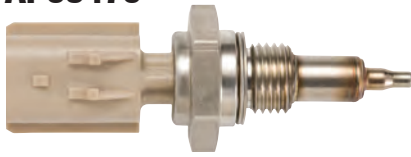

Exhaust Gas Recirculation (EGR) Temperature Sensor–Inlet

OEM Part Number: 1845988C1

Year Range:
2010–2016

Application:
MaxxForce 7

AP63471



Exhaust Gas Recirculation (EGR) Temperature Sensor–Outlet

OEM Part Number: 1888560C1

Year Range:
2010–2016

Application:
MaxxForce 7

AP63476



Manifold Absolute Pressure (MAP) Sensor

OEM Part Number: 1846481C92

Year Range:
2007–2016

Application:
MaxxForce 7

Electrical Harness and Repair

AP0021



3 Wire Pigtail

Notes: Fits AP63423 Exhaust Back Pressure (EBP) Sensor and AP63476 Manifold Absolute Pressure (MAP) Sensor.

Year Range:
2007–2010

Application:
MaxxForce 7

AP0056



2 Wire Pigtail

Notes: Fits AP63437 Engine Oil/Coolant//Fuel Temperature (EOT/ECT/FT) Sensor.

Year Range:
2007–2016

Application:
MaxxForce 7

EXCLUSIVE PARTS

AP63515



Injector Harness

OEM Part Number: 1856010C95

Notes: Injector harness for the right side.

Year Range:
2008–2010

Application:
MaxxForce 7

MAXXFORCE 7

continued **Electrical Harness and Repair**

Injector Harness

AP63516

OEM Part Number: 1856011C95

Notes: Injector harness for the left side.

Year Range: 2008–2010
Application: MaxxFace 7



Seal and Gasket Kits

Injection Line and O-ring Kit

AP0027

OEM Part Numbers: 1855644C3, 1886547C1, 1873425C93

Year Range: 2007–2016
Application: MaxxFace 7



Engine Oil Cooler Installation Kit

EXCLUSIVEKITS

AP0041

Notes: Installation kit only. If engine oil cooler is needed see AP63468 Engine Oil Cooler Kit.

Year Range: 2007–2010
Application: MaxxFace 7

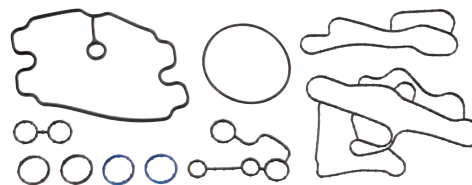

Exhaust Gas Recirculation (EGR) Valve O-ring

AP0042

OEM Part Number: 1847321C1

Year Range: 2007–2010
Application: MaxxFace 7



High-Pressure Fuel Pump (HPFP) Installation Kit

EXCLUSIVEKITS

AP0072

Notes: Pre-2010 emission engines. Installation kit only. If pump is needed see AP63644 Remanufactured High-Pressure Fuel Pump (HPFP) Kit.

Year Range: 2007–2010
Application: MaxxFace 7

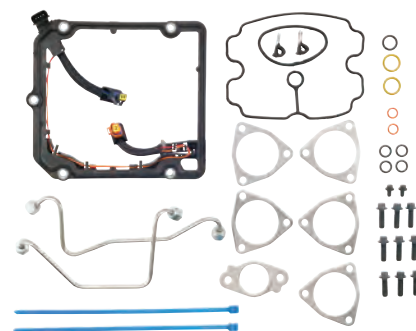

MAXXFORCE 7

Seal and Gasket Kits continued

AP0073 **EXCLUSIVEKITS**

High-Pressure Fuel Pump (HPFP) Installation Kit

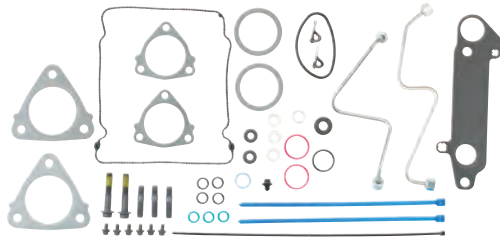

Notes: Post 2010 emission engines. Installation kit only. If pump is needed see AP63642 Remanufactured High-Pressure Fuel Pump (HPFP) Kit.

Year Range:
2010–2016

Application:
MaxxForce 7

AP63483

Turbo Installation Kit



OEM Part Number: 1876540C92

Notes: Pre-2010 emission engines.

Year Range:
2007–2010

Application:
MaxxForce 7

AP63484

Turbo Installation Kit



OEM Part Number: 1897455C93

Notes: Post 2010 emission engines.

Year Range:
2010–2016

Application:
MaxxForce 7

Engine Components

AP63585



Water Pump

OEM Part Number: 1832498C91, 1898956C91, 1886091C91, 1886066C1, 7081213C91

Notes: Includes necessary seals required for installation.

Year Range:
2007–2016

Application:
MaxxForce 7

Filters

PFL2016 RACOR



Oil Filter Element Service Kit

Year Range:
2007–2010

Application:
MaxxForce 7

MAXXFORCE 7

continued **Filters**

Oil Filter Cap

OEM Part Number: 1840754C91

Year Range:
2007–2010

Application:
MaxxForce 7



RK31821

RACOR.



Fuel Filter Kit

OEM Part Number: 1876533C93

Notes: Pre–2010 emission engines.

Year Range:
2007–2010

Application:
MaxxForce 7



RACOR.



PFF32715



Replacement Plastic Bowl with Drain

Notes: Pre–2010 emission engines.

Year Range:
2007–2010

Application:
MaxxForce 7

RACOR.



RK21113

Fuel Filter Insert Kit

OEM Part Number: 1884207C92

Notes: Post 2010 emission engines.

Year Range:
2010–2016

Application:
MaxxForce 7



RACOR.



PFF33286



Replacement Fuel Pump

OEM Part Numbers: 1884086C91, 7079720C91

Notes: Post 2010 emission engines.

Year Range:
2010–2016

Application:
MaxxForce 7

RACOR.



PFP58529



New OEM HEUI[®] injectors available exclusively through Alliant Power

- ▶ Brand new original equipment HEUI Injectors
- ▶ Complete 1995 to 2003 Navistar mid-range coverage
- ▶ Available exclusively through Alliant Power
- ▶ 24-month, unlimited mileage warranty in Navistar applications



DT466E, I530E, DT466 / 530, HT530

Injectors

HEUI Injector*

OEM Part Numbers: 1819834C1, 1823736C94, 1824917C2, 1824928C94, 2593588C91

Notes: Includes copper chamber gasket.

Year Range: 1995–1997	Application: DT466E: 230 HP (HT) to 250 HP (HT)	ESN Range: 933,834 to 1,084,867
---------------------------------	--	---

HEUI Injector*

OEM Part Numbers: 1824739C1, 1824742C91, 1824918C2, 1824929C94, 2593589C91

Notes: Includes copper chamber gasket.

Year Range: 1995–1997	Application: DT466E: 175 HP to 190 HP	ESN Range: 933,834 to 1,028,710
---------------------------------	--	---

HEUI Injector*

OEM Part Numbers: 1824740C1, 1824743C91, 1824919C2, 1824930C94, 2593590C91

Notes: Includes copper chamber gasket.

Year Range: 1995–1997	Application: DT466E: 195 HP (HT) to 230 HP (ST)	ESN Range: 933,834 to 1,028,710
---------------------------------	--	---

HEUI Injector*

OEM Part Numbers: 1824741C2, 1824744C94, 1824920C2, 1824931C94, 2593591C91

Notes: Includes copper chamber gasket.

Year Range: 1995–1997	Application: I530E: 250 (HP) (ST) to 300 HP (HT)	ESN Range: 933,834 to 1,084,028
---------------------------------	---	---

HEUI Injector*

OEM Part Numbers: 1824839C94, 1829336C1, 1829837C2, 1829838C94, 1829839C93, 1829926C2, 2593592C91

Notes: Includes copper chamber gasket.

Year Range: 1997–1999	Application: DT466E: 175 HP to 230 HP	ESN Range: 1,028,711 to 1,194,038
---------------------------------	--	---

HEUI Injector*

OEM Part Numbers: 1830145C91, 1830146C94, 1830147C2, 1830148C2, 2593593C91

Notes: Includes copper chamber gasket.

Year Range: 1998–1999	Application: I530E: 250 HP to 300 HP (HT)	ESN Range: 1,084,029 to 1,134,350
---------------------------------	--	---



AP63805BA

AP63806BB

AP63807BC

EXCLUSIVE PARTS

AP63808BD

AP63809BE

AP63810BF

**Indicates products with a core charge.*

DT466E, I530E, DT466 / 530, HT530

Injectors continued

AP63811BI



HEUI Injector*

OEM Part Numbers: 1830559C91, 1830560C2, 1830561C92, 1830562C2, 1830740C92, 1830741C92, 2593594C91, 2593595C91

Notes: Includes stainless steel and copper chamber gaskets.

Year Range:	Application:	ESN Range:
1999	DT466E: 175 HP to 250 HP (HT)	1,125,228 to 1,999,999
2000–2003	DT466: 175 HP to 250 HP (HT)	1,125,228 to 1,999,999

BG

HEUI Injector

OEM Part Numbers: 1830155C91, 1830156C91, 1830157C1, 1830158C1, 1830570C91, 1830573C2, 2593596C91

Notes: Discontinued, supersedes to AP63812BJ HEUI Injector.

Year Range:	Application:	ESN Range:
1997–1999	DT466E: 230 HP (HT) to 250 HP (HT)	1,084,868 to 1,125,227

EXCLUSIVE PARTS

AP63812BJ

HEUI Injector*

OEM Part Numbers: 1830094C92, 1830570C92, 1830571C2, 1830572C93, 1830573C2, 2593596C91

Notes: Includes copper chamber gasket.

Year Range:	Application:	ESN Range:
1999	I530E: 230 HP (HT) to 300 HP (HT)	1,133,755 to 1,194,038

AP63813BN

HEUI Injector*

OEM Part Numbers: 1830691C1, 1830692C91, 1830693C1, 1830694C93, 2593597C91

Notes: Includes stainless steel chamber gasket.

Year Range:	Application:	ESN Range:
2000–2003	DT530, HT530: 250 HP to 340 HP (HT)	1,194,039 to 1,999,999

AP63814BP

HEUI Injector*

OEM Part Numbers: 1836250C1, 1836251C91, 1836252C91, 1836253C1

Notes: Includes stainless steel chamber gasket.

Year Range:	Application:
2000 and Later	DT466 Transit

* Indicates products with a core charge.

DT466E, I530E, DT466 / 530, HT530

Engine Components

HEUI Injector Sleeve—Stainless Steel

OEM Part Number: 1818778C3

Notes: Engines built ON or AFTER 03/1996.

Year Range:	Application:
1996–1999	DT466E, I530E
2000–2003	DT466 / 530, HT530

AP63434



Engine Oil Cooler

OEM Part Number: 1815904C2

Year Range:	Application:
1995–1999	DT466E, I530E
2000–2003	DT466 / 530, HT530

AP63452

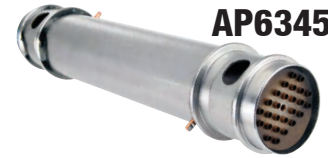

Water Pump

OEM Part Numbers: 1817687C92, 1821935C3, 1830606C94

Notes: Includes mounting gasket. Engines built ON or AFTER 09/1993.

Year Range:	Application:
1994–1999	DT466E, I530E
2000–2003	DT466 / 530, HT530

AP63580



Remanufactured High-Pressure Oil Pump

OEM Part Numbers: 1830177C92, 1842722C91

Notes: Includes mounting gasket. 6.5cc pump.

Year Range:	Application:
1994–1999	I530E: 230 HP (HT) to 300 HP
2000–2003	DT466 / 530, HT530: 230 HP (HT) to 300 HP



HP020X

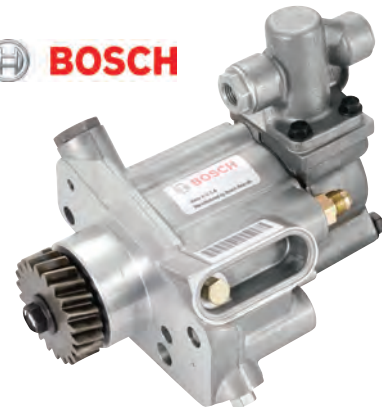

Remanufactured High-Pressure Oil Pump

OEM Part Numbers: 1825681C95, 1842721C91

Notes: Includes mounting gasket. 5.3cc pump.

Year Range:	Application:
1994–1999	DT466E: 175 HP to 230 HP
2000–2003	DT466: 175 HP to 230 HP

HP021X

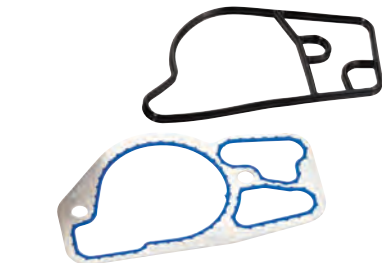

Remanufactured High-Pressure Oil Pump

OEM Part Numbers: 1842723C91, 1826458C92

Notes: Includes mounting gasket. 7.0cc pump.

Year Range:	Application:
1994–1999	I530E: 300 HP to 330 HP
2000–2003	DT530, HT530: 300 HP to 330 HP

HP022X

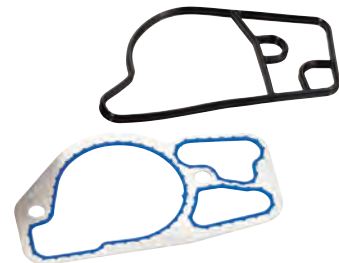

DT466E, I530E, DT466 / 530, HT530

Sensors

AP63429



Pressure Sensor

OEM Part Number: 1840078C1

Notes: Manifold Absolute Pressure (MAP) Sensor. Mounts on intake manifold.

Year Range:
1998–2003

Application:
DT466E, I530E, DT466 / 530, HT530

AP63465



Injection Control Pressure (ICP) Sensor

OEM Part Number: 1830669C92

Year Range:
See ESN

Application:
DT466E, I530E,
DT466 / 530, HT530

ESN Range:
1,134,351 to 1,999,999

AP63466



Engine Oil Pressure (EOP) Sensor

OEM Part Number: 1807369C2

Year Range:
See ESN

Application:
DT466E, I530E,
DT466 / 530, HT530

ESN Range:
1,126,949 to 1,999,999

Actuators

AP63401



Injection Pressure Regulator (IPR) Valve

OEM Part Numbers: 1824982C91, 1833798C91, 1841279C91

Notes: With edge filter.

Year Range:
1994–1995½

Application:
DT466E, I530E

ESN Range:
0 to 998,705

AP63402



Injection Pressure Regulator (IPR) Valve

OEM Part Numbers: 1829856C91, 1836412C91, 1841086C91, 1841217C91

Notes: Without edge filter.

Year Range:
1995½–2003
2000–2003

Application:
DT466E, I530E
DT466 / 530, HT530

ESN Range:
998,706 to 1,999,999
998,706 to 1,999,999

DT466E, I530E, DT466 / 530, HT530

Electrical Harness and Repair

3 Wire Pigtail

AP0021

Notes: Fits AP63465 Injection Control Pressure (ICP) Sensor and AP63466 Engine Oil Pressure (EOP) Sensor.

Year Range:
1994–2003

Application:
DT466E, I530E, DT466 / 530, HT530



2 Wire Pigtail

AP0068

Notes: Fits AP63401 and AP63402 Injection Pressure Regulator (IPR) Valves and all HEUI B Injectors.

Year Range:
1994–1999
2000–2003

Application:
DT466E, I530E
DT466 / 530, HT530



Internal Injector Harness

AP63464

OEM Part Numbers: 1889905C91, 30360R1, 1824908C1

Notes: Includes mounting bolts.

Year Range:
1994–2003

Application:
DT466E, I530E, DT466 / 530, HT530



Seal and Gasket Kits

HEUI Injector Seal Kit

AP0001

OEM Part Number: 1833564C92

Year Range:
1994–1999
2000–2003

Application:
DT466E, I530E
DT466 / 530, HT530



Injection Pressure Regulator (IPR) Valve Seal Kit

AP0003

OEM Part Number: 1825806C91

Year Range:
1994–1999
2000–2003

Application:
DT466E, I530E
DT466 / 530, HT530

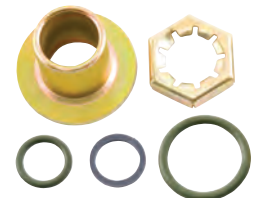

DT466E, I530E, DT466 / 530, HT530

Seal and Gasket Kits continued

AP0006

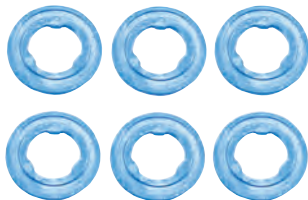

Stainless Steel Chamber Gaskets

OEM Part Number: 1830317C1

Notes: Package of six.

Year Range:
As Required

Application:
DT466E, I530E, DT466 / 530, HT530

AP0036

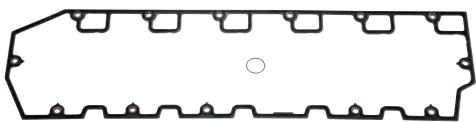

Valve Cover Gasket

OEM Part Numbers: 1820909C1, 1825602C91

Year Range:
1994–1999
2000–2003

Application:
DT466E, I530E
DT466 / 530, HT530

AP0038 **EXCLUSIVEKITS**



Primer Pump Seal Kit

Year Range:
1995–2003

Application:
DT466E, I530E, DT466 / 530, HT530

**Please visit AlliantPower.com for
up-to-date New Product Announcements,
Sales Flyers and Technical Bulletins.**



PERKINS, DETROIT DIESEL, AGCO

Injectors

AP63805BA



HEUI Injector*

OEM Part Numbers: 1819834C1, 1823736C94, 1824917C2, 1824928C94, 2593588C91

Notes: Includes copper chamber gasket.

Year Range:
1995–1997

Engine:
7.6L Perkins 1300 Series EDi

AP63808BD

HEUI Injector*

OEM Part Numbers: 1824741C2, 1824744C94, 1824920C2, 1824931C94, 2593591C91

Notes: Includes copper chamber gasket.

Year Range:
1995–1997

Engine:
8.7L Perkins 1300 Series EDi

AP63810BF

EXCLUSIVE PARTS

HEUI Injector*

OEM Part Numbers: 1830145C91, 1830146C94, 1830147C2, 1830148C2, 2593593C91

Notes: Includes copper chamber gasket.

Year Range:
1998–1999
1998–1999
1998–1999

Engine:
8.7L Perkins 1300 Series EDi
8.7L Detroit Diesel Series 40E
8.7L AGCO 9675

AP63811BI

HEUI Injector*

OEM Part Numbers: 1830559C91, 1830560C2, 1830561C92, 1830562C2, 1830740C92, 1830741C92, 2593594C91, 2593595C91

Notes: Includes stainless steel and copper chamber gaskets.

Year Range:
1999–2003

Engine:
7.6L Perkins 1300 Series EDi

AP63812BJ

HEUI Injector*

OEM Part Numbers: 1830094C92, 1830570C92, 1830571C2, 1830572C93, 1830573C2, 2593596C91

Notes: Includes copper chamber gasket.

Year Range:
1999
1999

Engine:
8.7L Perkins 1300 Series EDi
8.7L Detroit Diesel Series 40E

PERKINS, DETROIT DIESEL, AGCO

continued **Injectors**

HEUI Injector*

OEM Part Numbers: 1830691C1, 1830692C91, 1830693C1, 1830694C93, 2593597C91

Notes: Includes stainless steel chamber gasket.

Year Range:	Engine:
2000–2003	8.7L Perkins 1300 Series EDi
2000–2003	8.7L Detroit Diesel Series 40E

HEUI Injector*

OEM Part Numbers: 1836250C1, 1836251C91, 1836252C91, 1836253C1

Notes: Includes stainless steel chamber gasket.

Year Range:	Engine:
2000 and Later	7.6L Detroit Diesel Series 40E

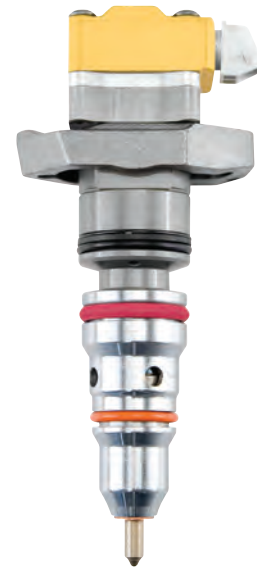

AP63813BN

AP63814BP

EXCLUSIVE PARTS

Seal and Gasket Kits

HEUI Injector Seal Kit

OEM Part Number: 1833564C92

Year Range:	Engine:
1995–1997	7.6L Perkins 1300 Series EDi
1999–2003	7.6L Perkins 1300 Series EDi
1995–2003	8.7L Perkins 1300 Series EDi
1998–2003	8.7L Detroit Diesel Series 40E
2000 and Later	7.6L Detroit Diesel Series 40E
1998–1999	8.7L AGCO 9675

AP0001



**Indicates products with a core charge.*



NEW

Spool Valve



NEW

Injector Coils



NEW

Connector

Alliant Power partners with PurePower Technologies®!

PurePower's industry leading remanufactured G2.9 injectors now available to the aftermarket through Alliant Power.

- ▶ Remanufactured by PurePower Technologies
 - 100% new injector coils, spool valve and connectors
 - 24-month, unlimited mileage warranty
- ▶ Complete 2004 to 2017 Navistar mid-range coverage
- ▶ Brand new injectors also available



DT466 / 570, HT570, MAXXFORCE DT / 9 / 10, N9 / N10

Injectors

PPT Remanufactured G2.9 Injector* PPT New G2.9 Injector*

OEM Part Numbers: 1842576C94, 5010656R92, 1841491C91, 1842223C91, 6905-PP, 6922-PP

Notes: Installation requires removal of high-pressure oil rail. Use AP0025 High-Pressure Oil Rail Seal Kit when reinstalling oil rail.

Year Range:	Application:	ESN Range:
2004	DT466: 210 HP to 225 HP	2,000,001 to 2,999,999

PPT Remanufactured G2.9 Injector* PPT New G2.9 Injector*

OEM Part Numbers: 1842577C94, 5010657R92, 1842224C91, 6906-PP, 6923-PP

Notes: Installation requires removal of high-pressure oil rail. Use AP0025 High-Pressure Oil Rail Seal Kit when reinstalling oil rail.

Year Range:	Application:	ESN Range:
2004	DT466: 245 HP to 285 HP (HT)	2,000,001 to 2,999,999
2005	DT466: 210 HP to 285 HP	2,000,001 to 2,999,999

PPT Remanufactured G2.9 Injector* PPT New G2.9 Injector*

OEM Part Numbers: 1842578C95, 5010658R92, 1842225C91, 6907-PP, 6924-PP

Notes: Installation requires removal of high-pressure oil rail. Use AP0025 High-Pressure Oil Rail Seal Kit when reinstalling oil rail.

Year Range:	Application:	ESN Range:
2004-2005	DT570: 285 HP to 330 HP	2,000,001 to 2,999,999

PPT Remanufactured G2.9 Injector* PPT New G2.9 Injector*

OEM Part Numbers: 1842579C95, 5010659R92, 1842226C91, 6908-PP, 6925-PP

Notes: Installation requires removal of high-pressure oil rail. Use AP0025 High-Pressure Oil Rail Seal Kit when reinstalling oil rail.

Year Range:	Application:	ESN Range:
2004-2005	HT570: 295 HP to 340 HP (HT)	2,000,001 to 2,999,999

PPT Remanufactured G2.9 BANG Injector* PPT New G2.9 BANG Injector*

OEM Part Numbers: 1848489C92, 5010983R91, 6909-PP, 6926-PP

Notes: Installation requires removal of high-pressure oil rail. Use AP0025 High-Pressure Oil Rail Seal Kit when reinstalling oil rail.

Year Range:	Application:
2006	DT466: 210 HP to 285 HP

PPT Remanufactured G2.9 BANG Injector* PPT New G2.9 BANG Injector*

OEM Part Numbers: 1848492C92, 5010984R91, 6910-PP, 6927-PP

Notes: Installation requires removal of high-pressure oil rail. Use AP0025 High-Pressure Oil Rail Seal Kit when reinstalling oil rail.

Year Range:	Application:
2006	DT570: 285 HP to 330 HP



AP66976
AP66876

AP66977
AP66877

AP66978
AP66878

purePOWER
TECHNOLOGIES

AP66979
AP66879

AP66989
AP66889

AP66992
AP66892

**Indicates products with a core charge.*

DT466 / 570, HT570, MAXXFORCE DT / 9 / 10, N9 / N10

Injectors continued

AP66995
AP66895



PPT Remanufactured G2.9 BANG Injector*
PPT New G2.9 BANG Injector*

OEM Part Numbers: 1848495C92, 5010985R91, 6911-PP, 6928-PP

Notes: Installation requires removal of high-pressure oil rail. Use AP0025 High-Pressure Oil Rail Seal Kit when reinstalling oil rail.

Year Range: 2006
Application: HT570: 295 HP to 340 HP (HT)

AP66918
AP66818

PPT Remanufactured G2.9 Injector*
PPT New G2.9 Injector*

OEM Part Numbers: 1848718C93, 5010561R93, 6912-PP, 6929-PP

Notes: Installation requires removal of high-pressure oil rail. Use AP0025 High-Pressure Oil Rail Seal Kit when reinstalling oil rail.

Year Range: 2007-2010
Application: MaxxFORCE DT: 210 HP to 300 HP
ESN Range: 3,000,001 to 3,300,000

AP66921
AP66821

PPT Remanufactured G2.9 Injector*
PPT New G2.9 Injector*

OEM Part Numbers: 1848721C93, 4307212R91, 5010823R91, 6913-PP, 6930-PP

Notes: Installation requires removal of high-pressure oil rail. Use AP0025 High-Pressure Oil Rail Seal Kit when reinstalling oil rail.

Year Range: 2007-2010
Application: MaxxFORCE 9: 300 HP to 330 HP
MaxxFORCE 10: 310 HP to 350 HP
ESN Range: 3,000,001 to 3,300,000

AP66955
AP66855



PPT Remanufactured G2.9 Injector*
PPT New G2.9 Injector*

OEM Part Numbers: 1890055C92, 1890056C2, 5010715R91, 6915-PP, 6932-PP

Notes: Installation requires removal of high-pressure oil rail. Use AP0025 High-Pressure Oil Rail Seal Kit when reinstalling oil rail.

Year Range: 2010-2014
Application: MaxxFORCE DT: 215 HP to 300 HP

AP66957
AP66857

PPT Remanufactured G2.9 Injector*
PPT New G2.9 Injector*

OEM Part Numbers: 1884057C92, 1884058C2, 5010986R91, 6914-PP, 6931-PP

Notes: Installation requires removal of high-pressure oil rail. Use AP0025 High-Pressure Oil Rail Seal Kit when reinstalling oil rail.

Year Range: 2010-2014
Application: MaxxFORCE DT: 210 HP to 225 HP

AP66958
AP66858

PPT Remanufactured G2.9 Injector*
PPT New G2.9 Injector*

OEM Part Numbers: 1890057C92, 1890058C2, 5010717R91, 6916-PP, 6933-PP

Notes: Installation requires removal of high-pressure oil rail. Use AP0025 High-Pressure Oil Rail Seal Kit when reinstalling oil rail.

Year Range: 2010-2014
2010-2014
2015-2017
Application: MaxxFORCE 9: 300 HP to 330 HP
MaxxFORCE 10: 310 HP to 350 HP
N9 / N10

DT466 / 570, HT570, MAXXFORCE DT / 9 / 10, N9 / N10

Engine Components

Water Pump

OEM Part Numbers: 1842664C92, 1842665C93

Notes: Includes mounting gasket.

Year Range:	Application:
2004–2006	DT466 / 570, HT570
2007–2010	MaxxForce DT / 9 / 10



12cc Remanufactured High-Pressure Oil Pump*

OEM Part Numbers: 1885043C92, 1885044C2, 1889323C93, 5010736R91, 5010755R92, 7093938C91

Notes: The corresponding AP63514 Injection Pressure Regulator (IPR) Valve is included.

Year Range:	Application:	ESN Range:
2010–2014	MaxxForce DT	3,300,001 to End

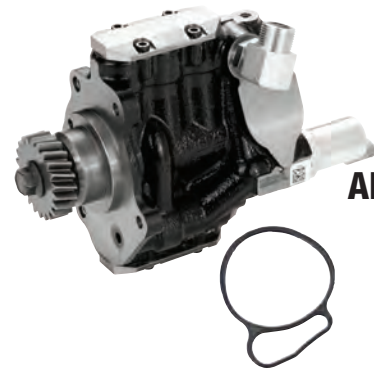

16cc High-Pressure Oil Pump*

OEM Part Numbers: 1885045C92, 1885046C2, 1889324C92, 5010755R92, 7093939C91

Notes: The corresponding AP63514 Injection Pressure Regulator (IPR) Valve is included.

Year Range:	Application:	ESN Range:
2010–2014	MaxxForce 9 / 10	3,300,001 to End
2015–2017	N9 / N10	

12cc Remanufactured High-Pressure Oil Pump*

OEM Part Numbers: 1883888C93, 1842424C2, 1871291C4, 1842423C97, 1871292C96, 1842614C91, 5011334R92

Notes: The corresponding AP63512 Injection Pressure Regulator (IPR) Valve and Fuel Supply Pump are included.

Year Range:	Application:	ESN Range:
2004–2006	DT466	2,000,001 to 2,999,999

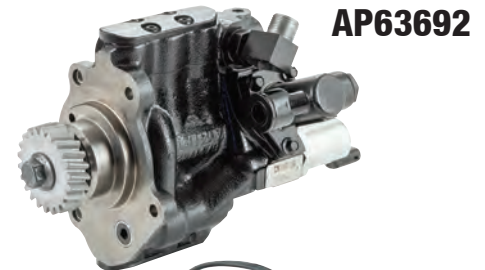

16cc Remanufactured High-Pressure Oil Pump*

OEM Part Numbers: 1885000C93, 1842426C2, 1842425C96, 1842617C91, 5011330R91

Notes: The corresponding AP63512 Injection Pressure Regulator (IPR) Valve and Fuel Supply Pump are included.

Year Range:	Application:	ESN Range:
2004–2006	DT570, HT570	2,000,001 to 2,999,999



*Indicates products with a core charge.

DT466 / 570, HT570, MAXXFORCE DT / 9 / 10, N9 / N10

Engine Components continued

AP63694



12cc Remanufactured High-Pressure Oil Pump Kit*

OEM Part Numbers: 1876105C95, 1832093C2, 1879744C2, 1832092C92, 1879743C93

Notes: Includes updated high–pressure hose and fitting. The corresponding AP63513 Injection Pressure Regulator (IPR) Valve and Fuel Supply Pump are included.

Year Range: 2007–2010	Application: MaxxForce DT	ESN Range: 3,000,001 to 3,040,000
---------------------------------	-------------------------------------	---

AP63695



16cc Remanufactured High-Pressure Oil Pump Kit*

OEM Part Numbers: 1882259C93, 1876106C94, 1832095C2, 1832094C92 5011332R91

Notes: Includes updated high–pressure hose and fitting. The corresponding AP63513 Injection Pressure Regulator (IPR) Valve and Fuel Supply Pump are included. OEM part numbers for both the early and late 16cc Remanufactured High–Pressure Pumps (AP63695 and AP63697) supersede to 1882259C93. The ESN must be used to determine which Alliant Power part number is required.

Year Range: 2007–2010	Application: MaxxForce 9 / 10	ESN Range: 3,000,001 to 3,040,000
---------------------------------	---	---

EXCLUSIVEKITS

AP63696

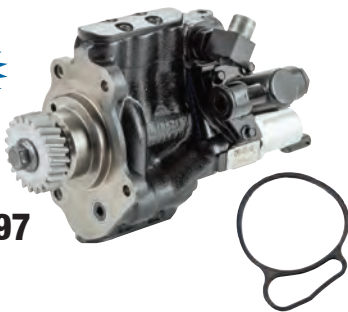

12cc Remanufactured High-Pressure Oil Pump*

OEM Part Numbers: 1882258C93, 1832093C2, 1879744C2, 1832092C92, 1879743C93

Notes: The corresponding AP63513 Injection Pressure Regulator (IPR) Valve and Fuel Supply Pump are included.

Year Range: 2007–2010	Application: MaxxForce DT	ESN Range: 3,040,001 to 3,300,000
---------------------------------	-------------------------------------	---

AP63697

16cc Remanufactured High-Pressure Oil Pump*

OEM Part Numbers: 1882259C93, 1832095C2, 1832094C92, 1879747C2, 1879745C93

Notes: The corresponding AP63513 Injection Pressure Regulator (IPR) Valve and Fuel Supply Pump are included. OEM part numbers for both the early and late 16cc Remanufactured High–Pressure Pumps (AP63695 and AP63697) supersede to 1882259C93. The ESN must be used to determine which Alliant Power part number is required.

Year Range: 2007–2010	Application: MaxxForce 9 / 10	ESN Range: 3,040,001 to 3,300,000
---------------------------------	---	---

* Indicates products with a core charge.

DT466 / 570, HT570, MAXXFORCE DT / 9 / 10, N9 / N10

Sensors

Engine Speed/Position Sensor

OEM Part Number: 1828345C91

Notes: Camshaft Speed/Position.

Year Range:	Application:
2004–2006	DT466 / 570, HT570
2007–2010	MaxxForce DT / 9 / 10



AP63412

Engine Speed/Position Sensor

OEM Part Number: 1835985C92

Notes: Crankshaft Speed/Position.

Year Range:	Application:
2004–2006	DT466 / 570, HT570
2007–2010	MaxxForce DT / 9 / 10



AP63415

Exhaust Back Pressure (EBP) Sensor

OEM Part Number: 1846480C2

Year Range:	Application:
2007–2010	MaxxForce DT / 9 / 10



AP63423

Engine Oil Pressure (EOP) Sensor

OEM Part Numbers: 1839415C91, 1837802C1, 1839832C1, 1872556C91

Notes: AP0021 3 Wire Pigtail can be used to repair the harness connector.

Year Range:	Application:
2004–2007	DT466 / 570
2007–2013	MaxxForce DT / 9 / 10



AP63474

Engine Oil/Coolant/Fuel Temperature (EOT/ECT/FT) Sensor

OEM Part Number: 1836537C91

Year Range:	Application:
2004–2006	DT466 / 570, HT570
2007–2010	MaxxForce DT / 9 / 10

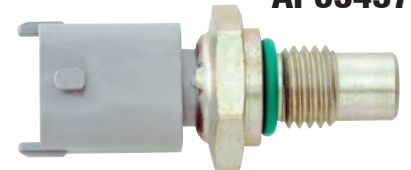

AP63437

Injection Control Pressure (ICP) Sensor

OEM Part Number: 1845536C91

Year Range:	Application:
2004–2007	DT466 / 570

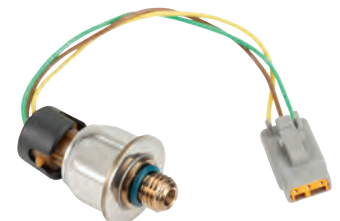

AP63567

DT466 / 570, HT570, MAXXFORCE DT / 9 / 10, N9 / N10

Sensors continued

AP63462

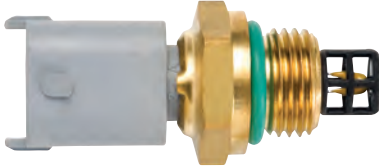

Intake Manifold Air Temperature (IAT) Sensor

OEM Part Number: 1836539C91

Year Range:
2004–2006

Application:
DT466 / 570, HT570

AP63471



Exhaust Gas Recirculation (EGR) Temperature Sensor–Outlet

OEM Part Number: 1888560C1

Year Range:
2010–2011

Application:
MaxxForce DT / 9 / 10

AP63476



Manifold Absolute Pressure (MAP) Sensor

OEM Part Number: 1846481C92

Year Range:
2007–2011

Application:
MaxxForce DT / 9 / 10

Actuators

AP63512



Injection Pressure Regulator (IPR) Valve

OEM Part Number: 1878571C95

Notes: Fits AP63692 12cc Remanufactured High–Pressure Oil Pump and AP63693 16cc Remanufactured High–Pressure Oil Pump. Includes valve and seal kit.

Year Range:
2004–2006

Application:
DT466 / 570, HT570

AP63513



Injection Pressure Regulator (IPR) Valve

OEM Part Number: 1878629C95

Notes: Fits AP63694 12cc Remanufactured High–Pressure Oil Pump Kit, AP63695 16cc Remanufactured High–Pressure Oil Pump Kit, AP63696 12cc Remanufactured High–Pressure Oil Pump, and AP63697 16cc Remanufactured High–Pressure Oil Pump. Includes valve and seal kit.

Year Range:
2007–2010

Application:
MaxxForce DT / 9 / 10

AP63514



Injection Pressure Regulator (IPR) Valve

OEM Part Number: 1889325C95

Notes: Fits AP63690 12cc Remanufactured High–Pressure Oil Pump and AP63681 16cc High–Pressure Oil Pump. Includes valve and seal kit.

Year Range:
2010–2014
2015–2017

Application:
MaxxForce DT / 9 / 10
N9 / N10

DT466 / 570, HT570, MAXXFORCE DT / 9 / 10, N9 / N10

Electrical Harness and Repair

3 Wire Pigtail

Notes: Fits AP63423 Exhaust Back Pressure (EBP) Sensor and AP63476 Manifold Absolute Pressure (MAP) Sensor.

Year Range: 2004–2006
2007–2010

Application: DT466 / 570, HT570
MaxxForce DT / 9 / 10



AP0021

2 Wire Pigtail

Notes: Fits AP63437 Engine Oil/Coolant/Fuel Temperature (EOT/ECT/FT) Sensor and AP63462 Intake Manifold Air Temperature (IAT) Sensor.

Year Range: 2004–2006
2007–2010

Application: DT466 / 570, HT570
MaxxForce DT / 9 / 10



AP0056

Fuel Injection Control Module (FICM) Connector

Notes: Field data shows identification marks 1456315–6, 1437287–7, or X–3.

Year Range: 2004–2006

Application: DT466 / 570, HT570

EXCLUSIVEPARTS

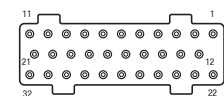

AP0018

Fuel Injection Control Module (FICM) Connector

Notes: Field data shows identification marks 1456315–2, 1437287–6, or X–2.

Year Range: 2004–2006

Application: DT466 / 570, HT570

EXCLUSIVEPARTS

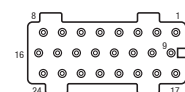

AP0019

Fuel Injection Control Module (FICM) Connector

Notes: Field data shows identification marks 1456316–1, 1437287–5, or X–1.

Year Range: 2004–2006

Application: DT466 / 570, HT570

EXCLUSIVEPARTS

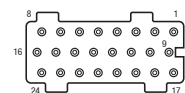

AP0020

2 Wire Pigtail

Notes: Fits the Injection Pressure Regulator (IPR) Valves.

Year Range: 2004–2006
2007–2013

Application: DT466 / 570, HT570
MaxxForce DT / 9 / 10



AP0068

EXCLUSIVEPARTS

DT466 / 570, HT570, MAXXFORCE DT / 9 / 10, N9 / N10

Seal and Gasket Kits

AP0006

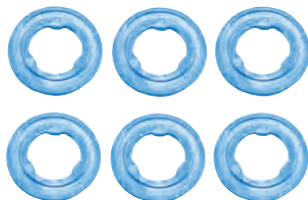

Stainless Steel Chamber Gaskets

OEM Part Number: 1830317C1

Notes: Package of six.

Year Range:

2004–2006

2007–2014

2015–2017

Application:

DT466 / 570, HT570

MaxxForce DT / 9 / 10

N9 / N10

AP0025



High-Pressure Oil Rail Seal Kit

OEM Part Number: 1842626C95

Year Range:

2004–2006

2007–2014

2015–2017

Application:

DT466 / 570, HT570

MaxxForce DT / 9 / 10

N9 / N10

ESN Range:

2,000,001 to 2,999,999

3,000,001 to End

AP0026



G2.9 Injector Seal Kit

OEM Part Number: 1842624C92

Year Range:

2004–2006

2007–2014

2015–2017

Application:

DT466 / 570, HT570

MaxxForce DT / 9 / 10

N9 / N10

AP0090



Injection Pressure Regulator (IPR) Valve Seal Kit

OEM Part Numbers: 1889027C91, 1878479C1

Notes: Seal kit only. If valve is needed see AP63512, AP63513, and AP63514 Injection Pressure Regulator (IPR) Valves.

Year Range:

2004–2006

2007–2014

2015–2017

Application:

DT466 / 570, HT570

MaxxForce DT / 9 / 10

N9 / N10

DT466 / 570, HT570, MAXXFORCE DT / 9 / 10, N9 / N10

continued **Seal and Gasket Kits**

High-Pressure Oil Rail Adapter

OEM Part Number: 1841923C98

Notes: AP0148 Oil Rail Adapter Socket required for installation.

Year Range:	Application:
2004–2006	DT466 / 570, HT570
2007–2014	MaxxForce DT / 9 / 10
2015–2017	N9 / N10

AP0149



Valve Cover Gasket

OEM Part Number: 1842380C95

Note: Without engine brake.

Year Range:	Application:
2004–2006	DT466 / 570, HT570

AP0161

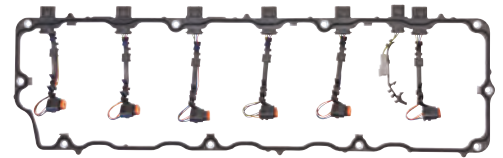

High-Pressure Oil Rail to Head O-ring

OEM Part Number: 1841581C1

Year Range:	Application:
2004–2007	DT466 / 570, HT570
2007–2015	MaxxForce DT / 9 / 10

AP0163



Please visit AlliantPower.com for
up-to-date New Product Announcements,
Sales Flyers and Technical Bulletins.







6.5L

Fuel System Components

AP63440



Fuel Transfer Pump

OEM Part Numbers: 25117340, EP309

Year Range: 1994–1999
Engine: 6.5L

AP63441



Fuel Transfer Pump

OEM Part Numbers: 15754298, EP1000

Year Range: 1999–2002
Engine: 6.5L

Engine Components

AP63560



Water Pump

OEM Part Numbers: 12530176, 19168610, 88894036, 251–590

Notes: Includes mounting gasket. Field data indicates both Water Pumps (AP63560 and AP63561) were used for MY 1999 vehicles. Be sure to verify which Water Pump is in place. Used for bolt-on pulley applications.

Year Range: 1994–1999
Engine: 6.5L F, S, or Y

AP63561



Water Pump

OEM Part Numbers: 12556231, 88894035, 251–603, 252–776

Notes: Includes mounting gasket. Field data indicates both Water Pumps (AP63560 and AP63561) were used for MY 1999 vehicles. Be sure to verify which Water Pump is in place. Used for press-on pulley applications.

Year Range: 1999–2003
Engine: 6.5L

Sensors

Engine Oil Pressure (EOP) Switch**OEM Part Numbers:** 12555492, D1808A**Year Range:** 1992–2002
Engine: 6.5L**AP63419****Crankshaft Position (CKP) Sensor****OEM Part Numbers:** 12557046, 213–337**Year Range:** 1994–2002
Engine: 6.5L**AP63444**

Actuators

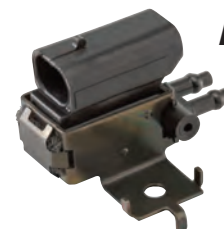
Glow Plug Relay**OEM Part Numbers:** 12496472, 212–366, RY383**Year Range:** 1994–2002
Engine: 6.5L**AP63420****Turbo Wastegate Solenoid****OEM Part Numbers:** 1997227, 214–1073**Year Range:** 1994–2002
Engine: 6.5L**AP63443**

Electrical Harness and Repair

Engine Oil Pressure (EOP) Switch Connector Pigtail**OEM Part Numbers:** 12085499, PT121**Year Range:** 1992–2002
Engine: 6.5L**AP0022****DS Pump 8" Wiring Harness Extension****Year Range:** 1994–2002
Engine: 6.5L**EXCLUSIVE PARTS AP0024**

6.5L

Electrical Harness and Repair continued

AP0034



Turbo Wastegate Solenoid Connector Pigtail

Year Range:
1994–2002

Engine:
6.5L

AP0067



Glow Plug Wire Harness Extension

OEM Part Number: 15320904

Year Range:
1994–2002

Engine:
6.5L

Seal and Gasket Kits

APE65110



DS Pump Installation Kit

Year Range:
1992–2002

Engine:
6.5L

EXCLUSIVEKITS

Engine Accessories

AP63701



Vacuum Pump–Mechanical

OEM Part Numbers: 7849209, 215–115

Notes: Also fits 6.2L.

Year Range:
1988–1995

Engine:
6.5L

AP63702



Vacuum Pump–Mechanical

OEM Part Numbers: 89017558, 215–479

Year Range:
1996–2002

Engine:
6.5L

DS Pump Components

PMD & Harness Kit**OEM Part Number:** 35976**Year Range:**
1994–2002**Engine:**
6.5L**EXCLUSIVEKITS AP63485****PMD Kit****OEM Part Number:** 40736**Year Range:**
1994–2002**Engine:**
6.5L**EXCLUSIVEKITS AP63486****EXCLUSIVEPARTS**

AP part number	Description	OEM part number
AP63546	Data Track Disc	30273
AP63547	Armature Plate Cover	30486
AP63548	ESO Actuator	33072
AP63549	Encoder Sensor	33883
AP63550	Stepper Motor Kit	34407
AP63551	Solenoid Assembly	36394
AP63552	Armature Assembly	39479
AP63553	Calibration Resistor #1	39859
AP63554	Calibration Resistor #2	39860
AP63555	Calibration Resistor #3	39861
AP63556	Calibration Resistor #4	39862
AP63557	Calibration Resistor #5	39863
AP63558	Calibration Resistor #6	39864
AP63559	Calibration Resistor #7	39865
AP63564	Calibration Resistor #8	39866
AP63565	Calibration Resistor #9	39867
AP0095	Overhaul Gasket Kit	33815

6.6L DURAMAX

Fuel System Components

AP63442



Fuel Transfer Pump

OEM Part Numbers: 15161174, EP1001, EP1020, 15821962, 23484581, EP1037, 23495127

Year Range:
2001–2014

Engine:
6.6L Duramax

AP0059



Fuel Return Line Banjo Bolt

OEM Part Number: 97228929

Year Range:
2001–2004

Engine:
6.6L LB7 Duramax

EXCLUSIVE PARTS

AP63720



Injection Line

OEM Part Number: 97188720

Notes: Cylinders 1 and 8.

Year Range:
2001–2004

Engine:
6.6L LB7 Duramax

AP63721



Injection Line

OEM Part Number: 97188721

Notes: Cylinders 3 and 6.

Year Range:
2001–2004

Engine:
6.6L LB7 Duramax

AP63722



Injection Line

OEM Part Number: 97188722

Notes: Cylinders 4 and 5.

Year Range:
2001–2004

Engine:
6.6L LB7 Duramax

AP63723



Injection Line

OEM Part Number: 97188723

Notes: Cylinders 2 and 7.

Year Range:
2001–2004

Engine:
6.6L LB7 Duramax

6.6L DURAMAX

Engine Components

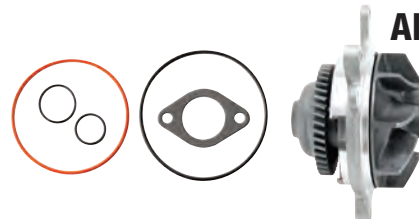
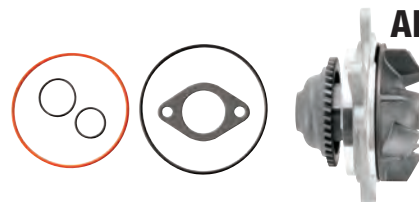
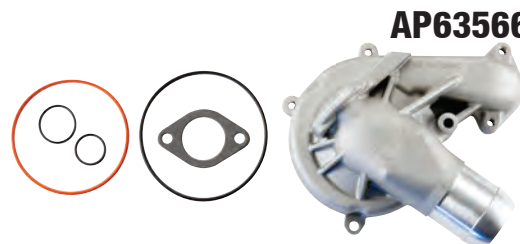
Turbo Hose**OEM Part Numbers:** 15019994, 15019995**Year Range:** 2001–2004
Engine: 6.6L LB7 Duramax**AP63457****Water Pump****OEM Part Numbers:** 97216136, 19113733, 19168888, 252–838, 251–674, 251–723**Notes:** Includes mounting gaskets.**Year Range:** 2001–2005
Engine: 6.6L Duramax**AP63562****Water Pump****OEM Part Numbers:** 98031233, 251–738, 12637105**Notes:** Includes mounting gaskets.**Year Range:** 2006–2014
Engine: 6.6L Duramax**AP63563****Water Pump Housing****OEM Part Number:** 97228188**Notes:** Fits AP63562 Water Pump.**Year Range:** 2001–2005
Engine: 6.6L LB7, LLY Duramax**AP63566**

Actuators

Turbocharger Vane Actuator**OEM Part Numbers:** 98061571, 792593–0001**Year Range:** 2004½–2010
2004–2009
Engine: 6.6L LLY, LBZ, LMM Duramax
6.6L TopKick / Kodiak 4500 / 5500**AP91000**

Electrical Harness and Repair

2 Wire Pigtail**Notes:** Fits AP91000 Turbocharger Vane Actuator**Year Range:** 2004½–2012
Engine: 6.6L LLY, LBZ, LMM, LML, LGH Duramax**AP0068****EXCLUSIVE PARTS**

6.6L DURAMAX

Seal and Gasket Kits

AP0029 **EXCLUSIVEKITS**

Fuel Filter Base and Hand Primer Seal Kit



Year Range:
2001–2016

Engine:
6.6L Duramax

AP0045 AP0062 **EXCLUSIVEKITS**

Head Installation Kit with Studs** Head Installation Kit without Studs

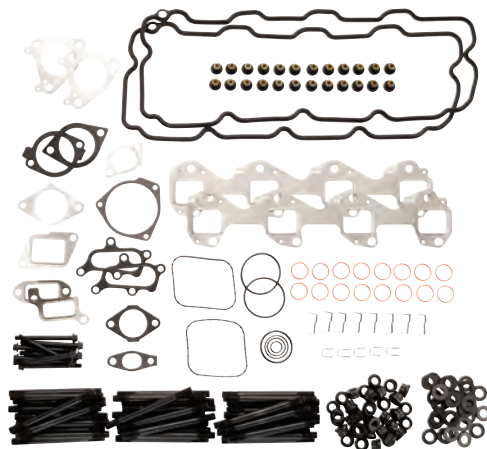

Notes: Head Gaskets sold separately refer to AP0047–AP0052.

Year Range:
2001–2004

Engine:
6.6L LB7 Duramax

Kit Contents:

- 2 Lower Valve Cover Gaskets
- 1 Exhaust Manifold Gasket Kit
- 1 Intake Manifold Gasket Kit
- 2 Thermostat Housing to Head Gaskets
- 1 Exhaust Gas Recirculation (EGR) System Gasket Kit
- 1 Water Pump to Outlet Pipe Gasket
- 1 Fuel Return Line Kit
- 16 Injector Cup Seals
- 1 Turbo Inlet Gasket
- 1 Coolant Bypass Pipe Seal Kit
- 1 Thermostat Housing to Coolant Outlet Pipe Seal
- 1 Thermostat Housing to Heater Pipe Seal
- 2 Fuel Injection Control Module (FICM) Banjo Seals
- **Includes Head Stud Kit



AP0046 AP0063 **EXCLUSIVEKITS**

Head Installation Kit with Studs** Head Installation Kit without Studs

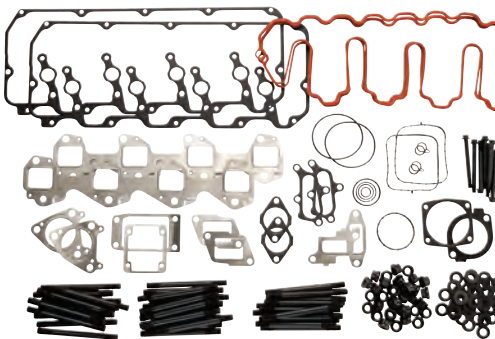

Notes: Head Gaskets sold separately refer to AP0047–AP0052.

Year Range:
2004½–2010

Engine:
6.6L LLY, LBZ, LMM Duramax

Kit Contents:

- 2 Upper Valve Cover Gaskets
- 2 Lower Valve Cover Gaskets
- 1 Exhaust Manifold Gasket Kit
- 1 Intake Manifold Gasket Kit
- 2 Thermostat Housing to Head Gaskets
- 1 Exhaust Gas Recirculation (EGR) System Gasket Kit
- 1 Water Pump to Outlet Pipe Gasket
- 1 Coolant Bypass Pipe Seal Kit
- 1 Thermostat Housing to Coolant Outlet Pipe Seal
- 1 Thermostat Housing to Exhaust Gas Recirculation (EGR) Cooler Pipe Seal
- 2 Fuel Injection Control Module (FICM) Banjo Seals
- **Includes Head Stud Kit



6.6L DURAMAX

continued **Seal and Gasket Kits**

Head Gasket Kit with Studs** Head Gasket Kit without Studs

Notes: Head Gaskets sold separately refer to AP0047–AP0052.

Year Range: 2011–2016 **Engine:** 6.6L LML Duramax **Application:** Silverado and Sierra Vehicles

- Kit Contents:**
- 2 Upper Valve Cover Gaskets
 - 2 Lower Valve Cover Gaskets
 - 2 Exhaust Manifold Gasket Kits
 - 2 Intake Manifold Gasket Kits
 - 1 Coolant Outlet Gasket
 - 1 Coolant Thermostat Housing Gasket
 - 1 Fuel Injection Throttle Body Gasket Kit
 - **Includes Head Stud Kit



EXCLUSIVE KITS AP0154 AP0155

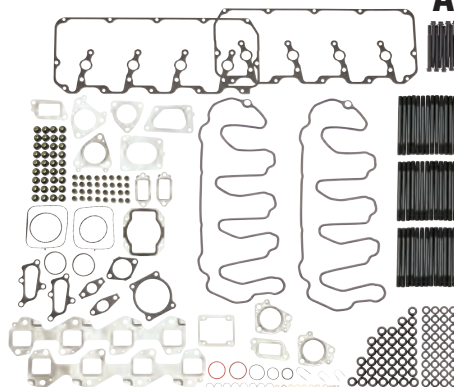

Head Gasket

OEM Part Numbers: 98045058, 12637787

Notes: 0.95 mm, Grade A, left.

Year Range: 2001–2015 **Engine:** 6.6L Duramax

AP0047

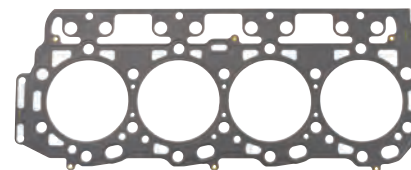

Head Gasket

OEM Part Numbers: 98045059, 12637786

Notes: 1.00 mm, Grade B, left.

Year Range: 2001–2015 **Engine:** 6.6L Duramax

AP0048

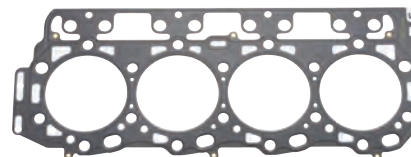

Head Gasket

OEM Part Numbers: 98045060, 12637785

Notes: 1.05 mm, Grade C, left.

Year Range: 2001–2015 **Engine:** 6.6L Duramax

AP0049

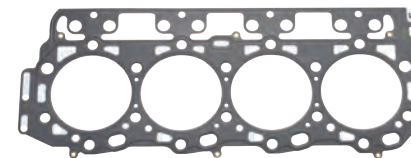

Head Gasket

OEM Part Numbers: 98045055, 12637790

Notes: 0.95 mm, Grade A, right.

Year Range: 2001–2015 **Engine:** 6.6L Duramax

AP0050

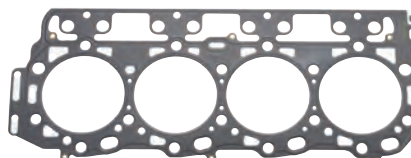

Head Gasket

OEM Part Numbers: 98045056, 12637789

Notes: 1.00 mm, Grade B, right.

Year Range: 2001–2015 **Engine:** 6.6L Duramax

AP0051

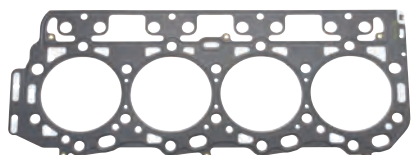

6.6L DURAMAX

Seal and Gasket Kits continued

AP0052

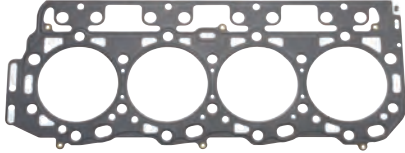

Head Gasket

OEM Part Numbers: 98045057, 12637788

Notes: 1.05 mm, Grade C, right.

Year Range:
2001–2015

Engine:
6.6L Duramax

AP0127 **EXCLUSIVEKITS**

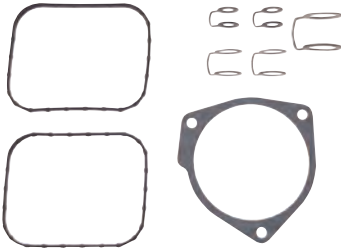

High-Pressure Fuel Pump Installation Kit

Year Range:
2001–2004

Engine:
6.6L LB7 Duramax

Application:
Silverado and Sierra Vehicles

AP0128 **EXCLUSIVEKITS**

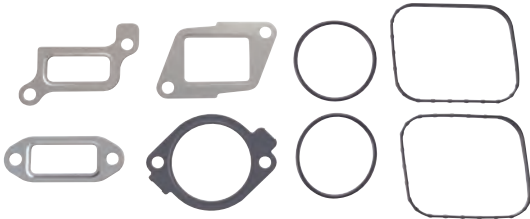

High-Pressure Fuel Pump/Exhaust Gas Recirculation (EGR) Valve Installation Kit

Year Range:
2004½–2005

Engine:
6.6L LLY Duramax

Application:
Silverado and Sierra Vehicles

AP0129 **EXCLUSIVEKITS**

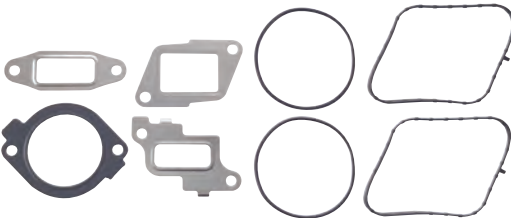

High-Pressure Fuel Pump/Exhaust Gas Recirculation (EGR) Valve Installation Kit

Year Range:
2006–2007

Engine:
6.6L LBZ Duramax

Application:
Silverado and Sierra Vehicles

AP0130 **EXCLUSIVEKITS**

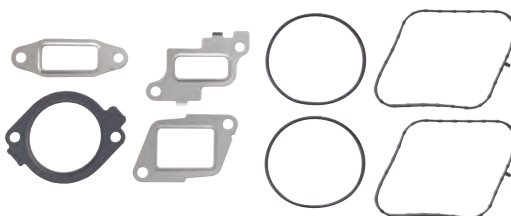

High-Pressure Fuel Pump/Exhaust Gas Recirculation (EGR) Valve Installation Kit

Year Range:
2007–2010

Engine:
6.6L LMM Duramax

Application:
Silverado and Sierra Vehicles

6.6L DURAMAX

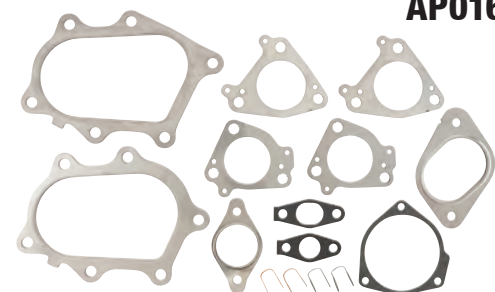
continued **Seal and Gasket Kits****Turbo Installation Kit****Year Range:**
2001–2010**Engine:**
6.6L LB7, LLY, LBZ, LMM Duramax**AP0162****Engine Accessories****Belt Tensioner****OEM Part Numbers:** 97329062, 38172, 89003343, 98094201, 97288625**Year Range:**
2002–2016**Engine:**
6.6L Duramax**AP63449****Starter****OEM Part Numbers:** 88864234, 336–1737**Year Range:**
2003–2011**Engine:**
6.6L Duramax**S14-101DAM****Filters****Oil Filter****OEM Part Numbers:** 88917036, PF2232**Year Range:**
2001 and Later**Engine:**
6.6L LB7, LLY, LBZ,
LMM, LML, LGH Duramax**Application:**
Silverado and Sierra Vehicles**RACOR****PFL5515****Fuel Filter Assembly****OEM Part Number:** 12642623**Year Range:**
2004½–2011**Engine:**
6.6L LLY, LBZ,
LMM, LML Duramax**Application:**
Silverado and Sierra Vehicles**PFF4245R2-02****RACOR**

6.6L DURAMAX

Filters continued

PFF50216



RACOR

Spin-on Fuel Filter**OEM Part Numbers:** 98017645, TP1298B, TP3018**Year Range:**
2001–2016**Engine:**
6.6L Duramax**Application:**
Silverado and Sierra Vehicles

PFF58567



RACOR

Fuel Filter Service Kit**Notes:** Primary and secondary.**Year Range:**
2004–2012**Engine:**
6.6L Duramax**Application:**
Express and Savana Vehicles

RK58010



RACOR

Replacement Plastic Bowl with Drain and WIF Sensor**OEM Part Number:** 19257915**Notes:** Use with PFF58567 Fuel Filter Service Kit. Van applications only.**Year Range:**
2004–2012**Engine:**
6.6L Duramax**Application:**
Express and Savana Vehicles

Please visit AlliantPower.com for
up-to-date New Product Announcements,
Sales Flyers and Technical Bulletins.



6.6L DURAMAX

continued **Filters****Drain Valve/Water Sensor Kit****Year Range:**
2001–2011**Engine:**
6.6L Duramax**Drain Valve/Water Sensor Kit****OEM Part Number:** 12651583**Year Range:**
2012 and Later**Engine:**
6.6L LML, LGH Duramax**Water Repelling Prescreen Filter****OEM Part Number:** 19259252**Notes:** Includes chassis cab and full size van (GMT 610).**Year Range:**
2012 and Later**Engine:**
6.6L LGH Duramax**Application:**
Express and Savana Vehicles

DODGE/CUMMINS



DODGE/CUMMINS

ENGINES WITH PT PUMPS

Fuel System Components

AP3035342

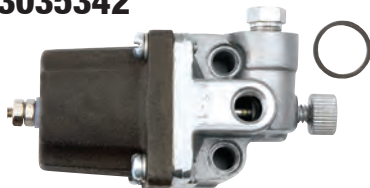

Fuel Shut-off Valve Assembly-12 Volt

OEM Part Number: 3035342

Year Range:
N/A

Engine:
PT Pumps

AP3035344



Fuel Shut-off Valve Assembly-24 Volt

OEM Part Number: 3035344

Year Range:
N/A

Engine:
PT Pumps

AP4024808



Fuel Shut-off Coil-12 Volt

OEM Part Number: 4024808

Year Range:
N/A

Engine:
PT Pumps

AP4024809



Fuel Shut-off Coil-24 Volt

OEM Part Number: 4024809

Year Range:
N/A

Engine:
PT Pumps

Fuel System Components

Fuel Transfer Pump

OEM Part Numbers: 3901425, 3904374, 3928143, 3966154, 3970880, 4983584

Year Range: 1989–1993
Engine: 5.9L B-Series, 12-Valve

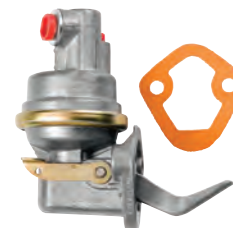

AP63478

Fuel Transfer Pump Kit

OEM Part Numbers: 3936316, 4988747, 4944710

Notes: Includes two mounting gaskets.

Year Range: 1994–1998
Engine: 5.9L B-Series, 12-Valve

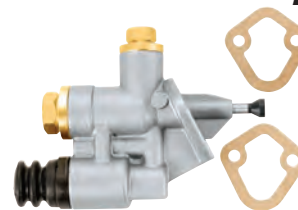

AP4988747

Fuel Transfer Pump Kit

OEM Part Numbers: 3990082, 3990105, 4932707, 4935730

Year Range: 1998–2003
Engine: 5.9L ISB with VP44

EXCLUSIVEKITS



AP4943048

Fuel Transfer Pump Kit

OEM Part Number: 3969705 (Hose)

Year Range: 2003–2004
Engine: 5.9L ISB with Common Rail

EXCLUSIVEKITS



AP4089602

Engine Components

Oil Cooler

OEM Part Numbers: 3921558, 3957544, 4713985AB

Year Range: 1993–1998
 1998–2003
Engine: 5.9L B-Series, 12-Valve
 5.9L ISB with VP44

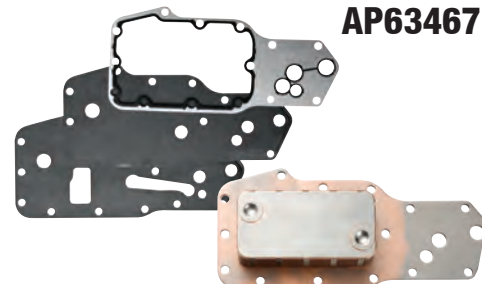

AP63467

EXCLUSIVEKITS

5.9L

Engine Components continued

AP63531

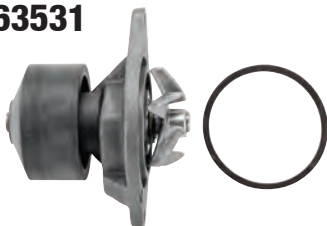

Water Pump

OEM Part Numbers: 3286278, 3286277

Notes: Includes mounting gasket. Supersedes AP63530 Water Pump.

Year Range:

1990–1998

1998–2003

Engine:

5.9L B-Series, 12-Valve

5.9L ISB with VP44

AP63532

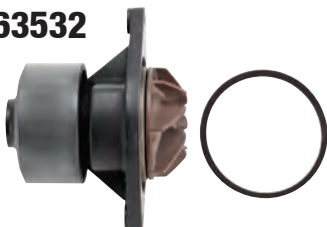

Water Pump

OEM Part Numbers: 3800984, 4891252

Notes: Includes mounting gasket.

Year Range:

2003–2007

Engine:

5.9L ISB with Common Rail

Sensors

AP63428



Accelerator Pedal Position Sensor (APPS)

OEM Part Numbers: 3970084, 53031575AH

Notes: For use with automatic transmissions.

Year Range:

1998–2003

Engine:

5.9L ISB with VP44

AP63427



Accelerator Pedal Position Sensor (APPS)

OEM Part Numbers: 3970085, 53031576AD

Notes: For use with manual transmissions.

Year Range:

1998–2003

Engine:

5.9L ISB with VP44

AP63458



Accelerator Pedal Position Sensor (APPS)

Notes: For use with automatic or manual transmissions.

Year Range:

1998–2003

2003–2004

Engine:

5.9L ISB with VP44

5.9L ISB with Common Rail

EXCLUSIVE PARTS

continued **Sensors**

Crankshaft Position (CKP) Sensor

OEM Part Number: 4921601

Year Range:
1998–2003

Engine:
5.9L ISB with VP44

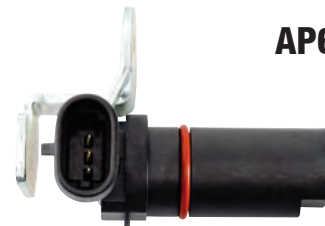

AP63453

Seal and Gasket Kits

Valve Cover Gasket

OEM Part Numbers: 3935878, 5016356AB

Year Range:
1998–2003

Engine:
5.9L ISB with VP44



AP0012

Intake Grid Heater Gaskets

OEM Part Number: 3969988

Year Range:
1989–1998
1998–2003
2003–2006

Engine:
5.9L B-Series, 12-Valve
5.9L ISB with VP44
5.9L ISB with Common Rail

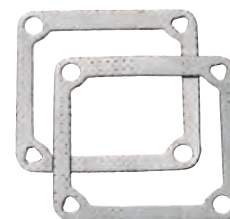

AP0058

Head Gasket Kit with Studs** Head Gasket Kit without Studs

Notes: Standard head gasket.

Year Range:
1998–2003

Engine:
5.9L ISB with VP44

Kit Contents:

- 1 Head Gasket
- 1 Valve Cover Gasket
- 6 Exhaust Manifold Gaskets
- 1 Intake Manifold Gasket Set
- 1 Turbo Gasket Set
- 1 Coolant Outlet Gasket
- **Includes Head Stud Kit



EXCLUSIVE KITS **AP0053**
AP0092

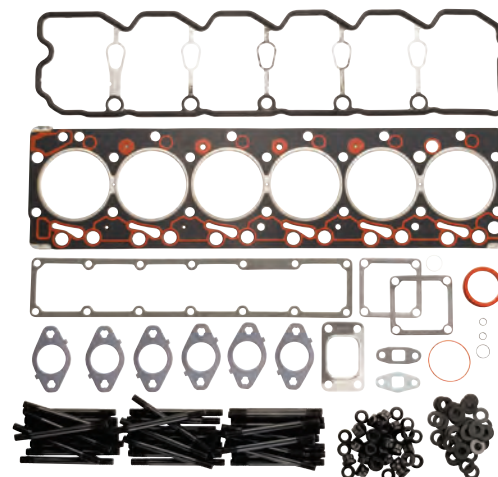

5.9L

Seal and Gasket Kits continued

AP0054 **EXCLUSIVE KITS** AP0093

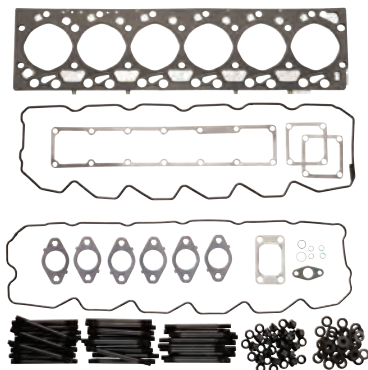

Head Gasket Kit with Studs** Head Gasket Kit without Studs

Notes: 1.10 mm head gasket.

Year Range:
2003–2006

Engine:
5.9L ISB with Common Rail

Kit Contents:

- 1 Head Gasket
- 1 Valve Cover Gasket
- 1 Rocker Housing Gasket
- 6 Exhaust Manifold Gaskets
- 1 Intake Manifold Gasket Set
- 1 Turbo Gasket Set
- **Includes Head Stud Kit



AP0055 **EXCLUSIVE KITS** AP0094

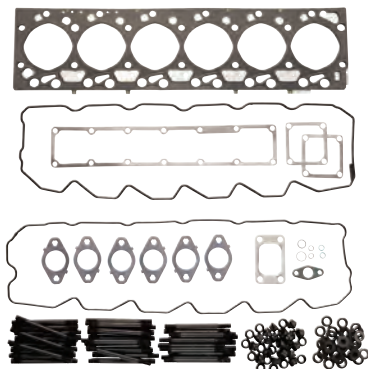

Head Gasket Kit with Studs** Head Gasket Kit without Studs

Notes: 1.20 mm head gasket.

Year Range:
2003–2006

Engine:
5.9L ISB with Common Rail

Kit Contents:

- 1 Head Gasket
- 1 Valve Cover Gasket
- 1 Rocker Housing Gasket
- 6 Exhaust Manifold Gaskets
- 1 Intake Manifold Gasket Set
- 1 Turbo Gasket Set
- **Includes Head Stud Kit



Engine Accessories

228000–2292



Starter

OEM Part Numbers: 3921682, 5016522AA

Year Range:
1994–1998
1998–2002

Engine:
5.9L B–Series, 12–Valve
5.9L ISB with VP44

428000–5940



Starter

OEM Part Numbers: 4090084, 5086932AA

Year Range:
2003–2006

Engine:
5.9L ISB with Common Rail

Filters

Fuel Filter Element

OEM Part Numbers: 4883963AC, 3990130

Notes: Includes filters for mechanical P Pump and VP44 fuel system.

Year Range:	Engine:
1997–1998	5.9L ISB with P Pump
1998½–1999	5.9L ISB with VP44



PFF19528

RACOR



Fuel Filter Element

OEM Part Numbers: 5015581AA, 4941252

Notes: Includes filters for VP44 and high-pressure common rail (HPCR) fuel system.

Year Range:	Engine:
2000–2002	5.9L ISB with VP44
2003–2010	5.9L ISB with Common Rail



PFF19579

RACOR

Please visit AlliantPower.com for
up-to-date New Product Announcements,
Sales Flyers and Technical Bulletins.



6.7L

Engine Components

AP63533

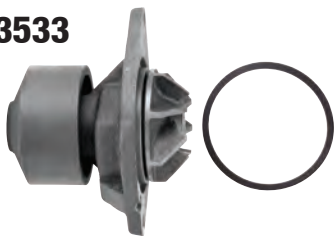

Water Pump

OEM Part Numbers: 2881804, 68003402AA, 4955359

Notes: Includes mounting gasket.

Year Range:
2007–2012

Engine:
6.7L ISB

Seal and Gasket Kits

AP0091 **EXCLUSIVE KITS**
AP0097

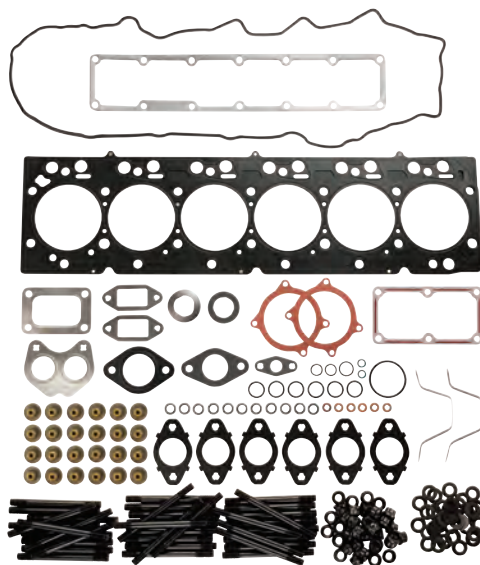

Head Gasket Kit with Studs**

Head Gasket Kit without Studs

Year Range:
2007–2013
2007–2009

Engine:
6.7L ISB 2500 / 3500
6.7L ISB 4500 / 5500

Kit Contents:

- 1 Head Gasket
- 1 Valve Cover Gasket
- 6 Exhaust Manifold Gaskets
- 1 Intake Manifold Gasket
- 1 Turbo Gasket Set
- **Includes Head Stud Kit



Spin-on Fuel Filter/Water Separator**OEM Part Number:** 68197867AA**Notes:** Frame mounted filter.**Year Range:**
2014 and Later**Engine:**
6.7L ISB with High-Pressure Common Rail (HPCR)**PFF54529****Drain Valve/Water Separator Kit****OEM Part Numbers:** 68197868AA / AB**Notes:** Frame mounted filter.**Year Range:**
2013 and Later**Engine:**
6.7L ISB with High-Pressure Common Rail (HPCR)**PFRK54553**

Please visit AlliantPower.com for
up-to-date New Product Announcements,
Sales Flyers and Technical Bulletins.



SPRINTER/JEEP

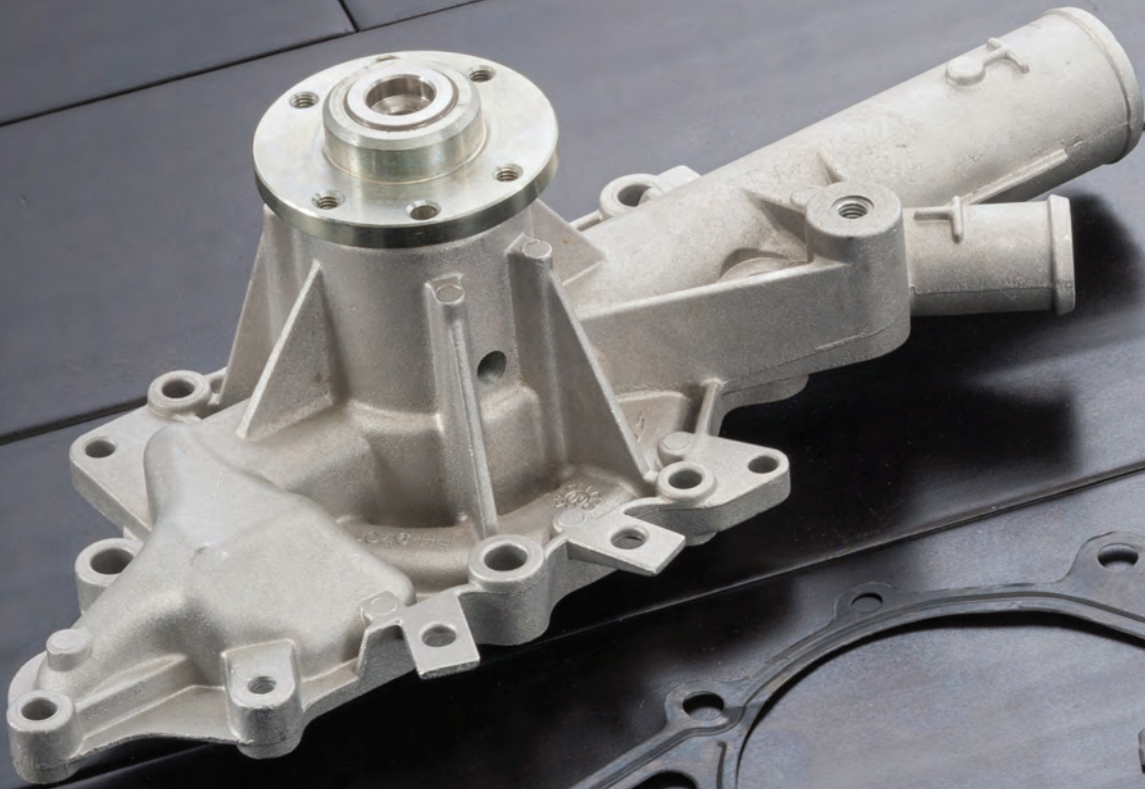

SPRINTER/JEEP



SPRINTER/JEEP

2.7L and 3.0L

Engine Components

AP63600



Water Pump

OEM Part Numbers: 5103576AA, 6112001101

Notes: Includes two mounting gaskets.

Year Range:
2002–2003

Engine:
2.7L OM 612

Application:
Sprinter 2500 / 3500

AP63601



Water Pump

OEM Part Numbers: 5138057AA, 6472000101

Notes: Includes mounting gasket.

Year Range:
2004–2006

Engine:
2.7L OM 647

Application:
Sprinter 2500 / 3500

Filters

AP61000



Oil Filter Element Service Kit

OEM Part Numbers: 0011849425, 5086301AA, 1121840025, 6111800009, A6111800009

Year Range:
2002–2003
2004–2006

Engine:
2.7L OM 612
2.7L OM 647

Application:
Sprinter 2500 / 3500
Sprinter 2500 / 3500

AP61001



Oil Filter Element Service Kit

OEM Part Numbers: 5175571AA, 6421800009, A6421800009

Year Range:
2007–2014
2007–2008

Engine:
3.0L OM 642
3.0L OM 642

Application:
Sprinter 2500 / 3500
Jeep Grand Cherokee

2.7L and 3.0L

continued **Filters**

Fuel Filter without WIF Sensor

OEM Part Numbers: 5103577AA, 6120920001, A6120920001

Notes: WIF sensor can be transferred from old filter to new filter.

Year Range:	Engine:	Application:
2002–2003	2.7L OM 612	Sprinter 2500 / 3500



AP61002

Fuel Filter without WIF Sensor

OEM Part Numbers: 5117492AA, 5170896AB, 5175425AB, 5175429AB, 6460920701, 6460900252, 6460920201, 6460920601

Notes: WIF sensor can be transferred from old filter to new filter.

Year Range:	Engine:	Application:
2004–2006	2.7L OM 647	Sprinter 2500 / 3500
2007–2009	3.0L OM 642	Sprinter 2500 / 3500
2007–2008	3.0L OM 642	Jeep Grand Cherokee



AP61003

Fuel Filter without WIF Sensor

OEM Part Number: 6420920301

Notes: WIF sensor can be transferred from old filter to new filter.

Year Range:	Engine:	Application:
2010–2012	3.0L OM 642	Sprinter 2500 / 3500



AP61005

Please visit AlliantPower.com for
up-to-date New Product Announcements,
Sales Flyers and Technical Bulletins.



ISUZU





4HK1 and 6HK1

High-Pressure Common Rail (HPCR)

AP53800



Remanufactured Common Rail Injector*

OEM Part Numbers: 8943922614, 8943921602, 94392261, 095000-0145, 095000-0190

Year Range:	Engine:	Application:
1998-2002	7.8L 6HK1 (LG4)	FSR, FTR, FVR
1999-2004	7.8L 6HK1 (82L)	FRR

AP53801



Remanufactured Common Rail Injector*

OEM Part Numbers: 8976012592, 97601259, 095000-0452

Year Range:	Engine:	Application:
2003	7.8L 6HK1 (LG4)	FSR, FTR, FVR, H Series

AP53802



Remanufactured Common Rail Injector*

OEM Part Numbers: 8976024362, 97602436, 095000-0452, 095000-0104

Year Range:	Engine:	Application:
2003	7.8L 6HK1 (LG4)	FSR, FTR, FVR

AP53903



Remanufactured Common Rail Injector*

OEM Part Numbers: 2901231000, 8973297035, 97780100, 095000-5471

Year Range:	Engine:	Application:
2004-2007	5.2L 4HK1 (RJS)	NPR, NPR-HD, NQR

AP53904



Remanufactured Common Rail Injector*

OEM Part Numbers: 2901233000, 8976028032, 97780452, 97602803, 095000-5360

Year Range:	Engine:	Application:
2004-2007	7.8L 6HK1 (LG4)	FTR, FVR, FXR, HTR, HVR, HXR

AP53905



Remanufactured Common Rail Injector*

OEM Part Numbers: 2901233100, 8976011562, 97780453, 97601156, 095000-5351

Year Range:	Engine:	Application:
2004-2007	7.8L 6HK1 (LG4)	FTR, FVR, FXR, HTR, HVR, HXR

AP53906



Remanufactured Common Rail Injector*

OEM Part Numbers: 2901233200, 8976097904, 97780454, 97609790, 095000-6384

Year Range:	Engine:	Application:
2007-2009	7.8L 6HK1 (LF8)	FTR, FVR, HTR, HVR

AP53907

Remanufactured Common Rail Injector*

OEM Part Numbers: 2901233300, 8976097915, 97780455, 97609791, 095000-6395

Year Range:	Engine:	Application:
2007-2010	5.2L 4HK1 (RJS, RDQ)	NPR, NPR-HD, NQR, NRR
2007-2009	7.8L 6HK1 (LF8)	FXR, HXR

4HK1 and 6HK1

continued **High-Pressure Common Rail (HPCR)**

Remanufactured Common Rail Injector*

OEM Part Numbers: 8981106074, 98110607, 095000-0323, 095000-6074

Year Range:	Engine:	Application:
2010-2013	5.2L 4HK1 (RJS, RDQ)	NRR, NQR
2013-2015	5.2L 4HK1 (RJS, RDQ)	NPR-HD

AP53808

Remanufactured Common Rail Injector*

OEM Part Numbers: 8982816111, 98281611, 095000-2130, 095000-6110

Year Range:	Engine:	Application:
2015 and Later	5.2L 4HK1 (RJS)	NPR-HD, NQR, NRR

AP53809



Notes for AP53800 to AP53802, AP53903 to AP53907, and AP53808 to AP53809:
Includes the necessary components needed for installation.

Seal and Gasket Kits

Injector Installation Kit

EXCLUSIVEKITS AP0150

Notes: Use with AP53800 to AP53802, AP53903 to AP53907 Remanufactured Common Rail Injectors.



Injector Installation Kit

EXCLUSIVEKITS AP0151

Notes: Use with AP53808 and AP53809 Remanufactured Common Rail Injectors.



* Indicates products with a core charge.

DIESEL FUEL TREATMENT



Complete Protection

Diesel fuel can vary in consistency and quality. Protect your engine's fuel system against substandard fuels by using Alliant Power Diesel Fuel Treatments. Our line of Diesel Fuel Treatments will help restore engine power, torque, and fuel economy through all seasons and operating conditions.

Alliant Power Fuel Treatments are formulated using technologically advanced chemistry designed to protect the most advanced high-pressure common rail diesel fuel systems as well as conventional systems. All are alcohol free, compatible with ultra-low sulfur diesel (ULSD), bio-diesel (up to B20), and exhaust aftertreatment emission systems (SCR & DPF). Alliant Power Fuel Treatments are compatible for all diesel engines, large or small, and for any application whether on-highway, off-highway, or marine.

ULTRAGUARD®



ULTRAGUARD is our all-season, multi-functional diesel fuel treatment that provides complete fuel system and injector protection for all diesel engines. ULTRAGUARD is designed to improve base diesel fuel quality and provide superior fuel system protection under all operating conditions.

Benefits:

- Restores engine power, torque, and fuel economy
- Increases cetane for improving engine combustion, faster cold starting, and smoother running
- Cleans/Eliminates injector deposits
- Eliminates injector "stiction" commonly associated with Common Rail Injectors
- Stabilizes fuel and protects against gums, varnishes, and rust/corrosion
- Lubricates fuel system
- Reduces ice formations of water in fuel
- Helps remove water by demulsification
- Provides Anti-Gel protection
- Helps minimize particulates in exhaust aftertreatment systems (SCR & DPF)

AP part number US	AP part number Canada	Size	Quantity per case	US gallons / liters treated
AP0500	AP0513	8 oz (237 mL)	24	30 gal (114L)
AP0501	AP0514	16 oz (473 mL)	12	60 gal (227L)
AP0502	AP0515	32 oz (946 mL)	12	125 gal (473L)
AP0503	AP0516	64 oz (1.9L)	6	250 gal (946L)
AP0504	AP0517	5 gal (19L)	1	2,500 gal (9,500L)
AP0505	AP0518	55 gal (208L)	1	27,500 gal (104,000L)

Note: Treatment rate 1:500

Please visit AlliantPower.com for additional information and Safety Data Sheets (SDS)

WINTERGUARD®

WINTERGUARD is our cold weather diesel fuel treatment designed to prevent common diesel fuel issues relating to extreme cold temperatures. Helps provide improved cold starting and cold weather engine performance.

Benefits:

- Provides Anti-Gel protection
- Improves cold filter plug point (CFPP) down to $-13^{\circ}\text{F}/-25^{\circ}\text{C}$ on average and as low as $-40^{\circ}\text{F}/-40^{\circ}\text{C}^{\dagger}$
- Reduces ice formations of water in fuel
- Economical per gallon treat rate

AP part number US	AP part number Canada	Size	Quantity per case	US gallons / liters treated
AP0506	AP0519	16 oz (473 mL)	12	125 gal (473L)
AP0507	AP0520	64 oz (1.9L)	6	500 gal (1,900L)
AP0508	AP0521	5 gal (19L)	1	5,000 gal (19,000L)
AP0509	AP0522	55 gal (208L)	1	55,000 gal (208,000L)

Note: Treatment rate 1:1000

†All Alliant Power Diesel Fuel Treatments can be blended with each other. Overtreating and double-dosing will increase effectiveness, but may not provide twice the benefit. Cetane and cold weather performance are dependent on the base fuel.



LUBRIGUARD®

LUBRIGUARD is our highly concentrated lubricating diesel fuel treatment with cetane improver that provides superior fuel system protection for all diesel engines. LUBRIGUARD has been developed using a unique combination of additives designed to supplement ULSD and dry fuels that are known to cause premature wear of the fuel system.

Benefits:

- Lubricates fuel system reducing friction & wear
- Restores engine power and torque
- Increases cetane for improved engine combustion and smoother running
- Concentrated lubricant to reduce friction/wear from dry fuels such as: Jet A, Kerosene, or #1 Diesel
- Helps maintain fuel system cleanliness
- Helps remove water by demulsification
- Stabilizes fuel and protects against gums, varnishes, and rust/corrosion
- Economical per gallon treat rate

AP part number US	AP part number Canada	Size	Quantity per case	US gallons / liters treated
AP0528	AP0529	8 oz (237 mL)	24	60 gal (227L)
AP0510	AP0523	16 oz (473 mL)	12	125 gal (473L)
AP0511	AP0524	64 oz (1.9L)	6	500 gal (1,900L)
AP0512	AP0525	5 gal (19L)	1	5,000 gal (19,000L)
AP0527	AP0526	55 gal (208L)	1	55,000 gal (208,000L)

Note: Treatment rate 1:1000



OEM PART NUMBER CROSS REFERENCE

OEM Part Number	AP Part Number	Page(s)	OEM Part Number	AP Part Number	Page(s)	OEM Part Number	AP Part Number	Page(s)
0 580 464 074	69136	6	1824455C94	AP63802AC	53	1830570C91	BG	82
0011849425	AP61000	126	1824456C96	AP63802AC	53	1830570C92	AP63812BJ	82, 88
095000-0104	AP53802	130	1824472C1	AP63802AC	53	1830571C2	AP63812BJ	82, 88
095000-0145	AP53800	130	1824473C2	AP63802AC	53	1830572C93	AP63812BJ	82, 88
095000-0190	AP53800	130	1824474C2	AP63802AC	53	1830573C2	AP63812BJ	82, 88
095000-0323	AP53808	131	1824582C94	AP63801AB	53	1830573C2	BG	82
095000-0452	AP53801	130	1824583C97	AP63801AB	53	1830606C94	AP63580	83
095000-0452	AP53802	130	1824739C1	AP63806BB	81	1830669C92	AP63465	84
095000-2130	AP53809	131	1824740C1	AP63807BC	81	1830691C1	AP63813BN	82, 89
095000-5351	AP53905	130	1824741C2	AP63808BD	81, 88	1830692C91	AP63813BN	82, 89
095000-5360	AP53904	130	1824742C91	AP63806BB	81	1830693C1	AP63813BN	82, 89
095000-5471	AP53903	130	1824743C91	AP63807BC	81	1830694C93	AP63813BN	82, 89
095000-6110	AP53809	131	1824744C94	AP63808BD	81, 88	1830740C92	AP63811BI	82, 88
095000-6384	AP53906	130	1824839C94	AP63809BE	81	1830741C92	AP63811BI	82, 88
095000-6395	AP53907	130	1824908C1	AP63464	85	1830844C93	AP63413	58
095000-9074	AP53808	131	1824917C2	AP63805BA	81, 88	1830857C91	HP007X	55
1121840025	AP61000	126	1824918C2	AP63806BB	81	1831196C91	AP63410	54, 61
12085499	AP0022	103	1824919C2	AP63807BC	81	1831259C92	AP63435	64
12496472	AP63420	103	1824920C2	AP63808BD	81, 88	1831449C91	HP008X	55
12530176	AP63560	102	1824928C94	AP63805BA	81, 88	1831487C92	AP63803AD	53
12555492	AP63419	103	1824929C94	AP63806BB	81	1831488C1	AP63803AD	53
12556231	AP63561	102	1824930C94	AP63807BC	81	1831489C12	AP63803AD	53
12557046	AP63444	103	1824931C94	AP63808BD	81, 88	1831550C14	AP63803AD	53
12637105	AP63563	107	1824982C91	AP63401	56, 84	1831551C13	AP63803AD	53
12637785	AP0049	109	1825125C1	AP63801AB	53	1831646C1	AP63405	56
12637786	AP0048	109	1825126C1	AP63801AB	53	1831658C91	AP63461	59
12637787	AP0047	109	1825186C91	AP63409	54	1831676C92	AP63581	54
12637788	AP0052	110	1825247C91	HP004X	55	1832092C92	AP63694	94
12637789	AP0051	109	1825248C91	HP005X	55	1832092C92	AP63696	94
12637790	AP0050	109	1825259C91	HP005X	55	1832093C2	AP63694	94
12642623	PPF4245R2-02	111	1825260C91	HP004X	55	1832093C2	AP63696	94
12651583	PFRK50309	113	1825271C93	HP004X	55	1832094C92	AP63695	94
15019994	AP63457	107	1825602C91	AP0036	86	1832094C92	AP63697	94
15019995	AP63457	107	1825681C95	HP021X	83	1832095C2	AP63695	94
15161174	AP63442	106	1825806C91	AP0003	58, 85	1832095C2	AP63697	94
15320904	AP0067	104	1825899C93	AP63400	56	1832498C91	AP63585	78
15754298	AP63441	102	1826458C92	HP022X	83	1833564C92	AP0001	58, 85, 89
15821962	AP63442	106	1826634C94	AP63405	56	1833639C1	AP63804AE	53
1807329C92	AP63418	56	1826703C1	AP0014	59	1833640C1	AP63804AE	53
1807369C2	AP63466	84	1826794C93	APM61067	54	1833644C1	AP63804AE	53
1814376C1	AP63411	54	1828345C91	AP63412	75, 95	1833645C1	AP63804AE	53
1815904C2	AP63452	54, 83	1829336C1	AP63809BE	81	1833646C92	AP63804AE	53
1815923C92	AP63414	58	1829837C2	AP63809BE	81	1833647C91	AP63804AE	53
1816187C3	AP63800AA	53	1829838C94	AP63809BE	81	1833798C91	AP63401	56, 84
1817687C92	AP63580	83	1829839C93	AP63809BE	81	1835985C92	AP63415	64, 75, 95
1818259C2	AP63800AA	53	1829856C91	AP63402	56, 84	1836250C1	AP63814BP	82, 89
1818350C2	AP0013	59	1829926C2	AP63809BE	81	1836251C91	AP63814BP	82, 89
1818778C3	AP63434	83	1830094C92	AP63812BJ	82, 88	1836252C91	AP63814BP	82, 89
1819834C1	AP63805BA	81, 88	1830145C91	AP63810BF	81, 88	1836253C1	AP63814BP	82, 89
1820909C1	AP0036	86	1830146C94	AP63810BF	81, 88	1836412C91	AP63402	56, 84
1821752C1	AP63800AA	53	1830147C2	AP63810BF	81, 88	1836537C91	AP63437	64, 75, 95
1821836C3	AP63800AA	53	1830148C2	AP63810BF	81, 88	1836539C91	AP63462	65, 96
1821935C3	AP63580	83	1830155C91	BG	82	1837802C1	AP63474	64
1822631C91	PPF4595	59	1830156C91	BG	82	1838250C1	AP0023	68
1822800C95	AP63800AA	53	1830157C1	BG	82	1838828C91	HP032X	63
1822801C91	AP63800AA	53	1830158C1	BG	82	1839415C91	AP63474	64
1822803C1	AP63801AB	53	1830177C92	HP020X	83	1839437C95	AP63416	66
1822890C1	AP63802AC	53	1830317C1	AP0006	86, 98	1839832C1	AP63474	64
1823561C1	AP63801AB	53	1830559C91	AP63811BI	82, 88	1840053C97	AP63481	70
1823736C94	AP63805BA	81, 88	1830560C2	AP63811BI	82, 88	1840078C1	AP63429	84
1823751C91	AP63803AD	53	1830561C92	AP63811BI	82, 88	1840702C97	AP63447	70
1824415C93	APM61067	54	1830562C2	AP63811BI	82, 88	1840754C91	RK31821	71, 79

OEM PART NUMBER CROSS REFERENCE

OEM Part Number	AP Part Number	Page(s)	OEM Part Number	AP Part Number	Page(s)	OEM Part Number	AP Part Number	Page(s)
1840778C91	AP0005	68	1856010C95	AP63515	76	1889027C91	AP0090	98
1840903C91	AP63479	66	1856011C95	AP63516	77	1890055C92	AP66855	92
1841086C91	AP63402	56, 84	1858088C92	AP0057	69	1890056C2	AP66855	92
1841217C91	AP63402	56, 84	1871291C4	AP63692	93	1890057C92	AP66858	92
1841279C91	AP63401	56, 84	1871292C96	AP63692	93	1890058C2	AP66858	92
1841491C91	AP66976	91	1872556C91	AP63474	64	1897455C93	AP63484	78
1841581C1	AP0163	99	1873400C92	AP63422	75	1898956C91	AP63585	78
1841923C98	AP0149	99	1873422C93	AP64900	73	1899239C92	AP64901	73
1842223C91	AP66976	91	1873425C93	AP0027	77	19113733	AP63562	107
1842224C91	AP66977	91	1875838C91	AP63463	65, 75	19168610	AP63560	102
1842225C91	AP66978	91	1876105C95	AP63694	94	19168888	AP63562	107
1842226C91	AP66979	91	1876106C94	AP63695	94	19257915	RK58010	112
1842380C95	AP0161	99	1876529C98	AP63644	74	19259252	PFFRK51216	113
1842423C97	AP63692	93	1876533C93	PFF32715	79	1997227	AP63443	103
1842424C2	AP63692	93	1876540C92	AP63483	78	1C3Z6A642AA	AP63452	7
1842425C96	AP63693	93	1876735C91	AP63400	56	1C3Z6C610BA	AP0004	12
1842426C2	AP63693	93	1876736C91	AP63491	55	1C3Z6K649BA	AP0004	12
1842576C93	AP66976	91	1877748C1	AP60901	61	1C3Z9D477AA	AP63404	7
1842577C93	AP66977	91	1878281C92	AP60900	61	1C3Z9J460AA	AP63429	9
1842578C94	AP66978	91	1878282C91	AP60900	61	212-366	AP63420	103
1842579C94	AP66979	91	1878284C91	AP60901	61	213-337	AP63444	103
1842614C91	AP63692	93	1878285C91	AP60901	61	214-1073	AP63443	103
1842617C91	AP63693	93	1878479C1	AP0090	98	215-115	AP63701	104
1842624C92	AP0026	98	1878571C95	AP63512	96	215-479	AP63702	104
1842626C95	AP0025	98	1878629C95	AP63513	96	2503701C91	HP004X	55
1842664C92	AP63582	93	1878865C91	AP63661	62	2503703C91	HP005X	55
1842665C93	AP63582	93	1879743C93	AP63694	94	2503704C91	HP007X	55
1842721C91	HP021X	83	1879743C93	AP63696	94	25117340	AP63440	102
1842722C91	HP020X	83	1879744C2	AP63694	94	251-590	AP63560	102
1842723C91	HP022X	83	1879744C2	AP63696	94	251-603	AP63561	102
1843057C92	PFF31795	70	1879745C93	AP63697	94	251-674	AP63562	107
1843089C91	AP60900	61	1879747C2	AP63697	94	251-723	AP63562	107
1843481C95	AP60900	61	1879998C91	AP60901	61	251-738	AP63563	107
1843682C91	AP0002	68	1880313C94	AP63663	63	252-776	AP63561	102
1844751C2	AP60901	61	1882258C93	AP63696	94	252-838	AP63562	107
1845002C91	AP63583	62	1882259C93	AP63695	94	2589446C91	HP008X	55
1845145C99	AP63446	62	1882259C93	AP63697	94	2593588C91	AP63805BA	81, 88
1845150C92	AP60901	61	1882919C92	AP63661	62	2593589C91	AP63806BB	81
1845274C92	AP63407	65	1883110C1	AP64901	73	2593590C91	AP63807BC	81
1845427C2	AP63460	65	1883111C91	AP64901	73	2593591C91	AP63808BD	81, 88
1845428C92	AP63460	65	1883888C93	AP63692	93	2593592C91	AP63809BE	81
1845536C91	AP63567	95	1884057C92	AP66857	92	2593593C91	AP63810BF	81, 88
1845879C91	AP60900	61	1884058C2	AP66857	92	2593594C91	AP63811BI	82, 88
1845988C1	AP63470	76	1884086C91	PFF58529	79	2593595C91	AP63811BI	82, 88
1846057C1	AP63417	66	1884207C92	PFF33286	79	2593596C91	AP63812BJ	82, 88
1846296C91	AP63459	66	1884357C92	AP63662	63	2593596C91	BG	82
1846480C2	AP63423	65, 75, 95	1885000C93	AP63693	93	2593597C91	AP63813BN	82, 89
1846481C92	AP63476	65, 76, 96	1885043C92	AP63690	93	2881804	AP63533	122
1846491C91	AP63438R	66	1885044C2	AP63690	93	2901231000	AP53903	130
1846692C92	AP60901	61	1885045C92	AP63681	93	2901233000	AP53904	130
1847321C1	AP0042	77	1885046C2	AP63681	93	2901233100	AP53905	130
1847913C91	AP63423	65, 75, 95	1886066C1	AP63585	78	2901233200	AP53906	130
1848489C91	AP66989	91	1886091C91	AP63585	78	2901233300	AP53907	130
1848492C91	AP66992	91	1886511C93	AP63451	62	2C3Z8V501BA	AP63501	7
1848495C91	AP66995	92	1886547C1	AP0027	77	2C3Z9C968BA	AP63401	10
1848718C92	AP66918	92	1888560C1	AP63471	76, 96	2C3Z9G804AB	AP0011	12
1848721C92	AP66921	92	1888696C93	AP0035	69	2L1Z9F479AA	AP63495	22
1850352C2	AP63408	64	1889249C91	AP63581	54	30273	AP63546	105
1850353C1	AP63403	56, 64	1889323C93	AP63690	93	3035342	AP3035342	116
1855644C3	AP0027	77	1889324C92	AP63681	93	3035344	AP3035344	116
1855839C95	AP63468	73	1889325C95	AP63514	96	30360R1	AP63464	85
1855860C94	AP63644	74	1889905C91	AP63464	85	30486	AP63547	105

OEM PART NUMBER CROSS REFERENCE

OEM Part Number	AP Part Number	Page(s)	OEM Part Number	AP Part Number	Page(s)	OEM Part Number	AP Part Number	Page(s)
3286277	AP63531	118	3C3Z9G270AA	PFF31795	30	5010736R91	AP63690	93
3286278	AP63531	118	3C3Z9H529A	AP0035	26	5010755R91	AP63690, AP63681	93
33072	AP63548	105	3C3Z9P455AB	AP0005	26	5010755R92	AP63690	93
33815	AP0095	105	3C3Z9T514AG	AP63481	28	5010756R92	AP63642	74
33883	AP63549	105	3C3Z9T517AG	AP0086	27	5010889R91	AP64901	73
336-1737	S14-101DAM	111	3L3Z12B579ARM	AP63494	23	5011330R91	AP63693	93
34407	AP63550	105	40736	AP63486	105	5011332R92	AP63695	94
35976	AP63485	105	4024808	AP4024808	116	5011334R92	AP63692	93
36394	AP63551	105	4024809	AP4024809	116	5015581AA	PFF19579	121
3800984	AP63532	118	4090084	428000-5940	120	5016356AB	AP0012	119
38172	AP63449	111	4307212R91	AP66921	92	5016522AA	228000-2292	120
3901425	AP63478	117	4307291R91	AP63644	74	5086301AA	AP61000	126
3904374	AP63478	117	4307325R91	AP63662	63	5086932AA	428000-5940	120
3921558	AP63467	117	4307327R91	AP63663	63	5103576AA	AP63600	126
3921682	228000-2292	120	4307329R91	AP63661	62	5103577AA	AP61002	127
3928143	AP63478	117	4307369R91	AP64900	73	5117492AA	AP61003	127
3935878	AP0012	119	4307381R91	AP64900	73	5138057AA	AP63601	126
3936316	AP4988747	117	4713985AB	AP63467	117	5170896AB	AP61003	127
39479	AP63552	105	4883963AC	PFF19528	121	5175425AB	AP61003	127
3957544	AP63467	117	4891252	AP63532	118	5175429AB	AP61003	127
3966154	AP63478	117	4921601	AP63453	119	5175571AA	AP61001	126
3969705 (Hose)	AP4089602	117	4932707	AP4943048	117	53031575AH	AP63428	118
3969988	AP0058	119	4935730	AP4943048	117	53031576AD	AP63427	118
3970084	AP63428	118	4941252	PFF19579	121	5C3Z12224A	AP0021	11, 24, 38
3970085	AP63427	118	4944710	AP4988747	117	5C3Z6F089A	AP91000	23, 46
3970880	AP63478	117	4955359	AP63533	122	5C3Z6F089BA	AP91000	23, 46
39859	AP63553	105	4983584	AP63478	117	5C3Z9A543ARM	AP63661	19
39860	AP63554	105	4988747	AP4988747	117	5C3Z9A543C	AP63661	19
39861	AP63555	105	4C2Z2A451AA	AP63703	29	5C3Z9C968CA	AP63417	23
39862	AP63556	105	4C2Z6766BA	RK32138	31	5C3Z9F452AA	AP63439R	23
39863	AP63557	105	4C2Z9A343AA	RK58052	30	5C3Z9F452ARM	AP63439R	23
39864	AP63558	105	4C3Z12B599AB	AP65122	18	5C3Z9J460A	AP63408	22
39865	AP63559	105	4C3Z12B599AB	AP65123	18	5C3Z9J460B	AP63408	22
39866	AP63564	105	4C3Z12B599AB	AP65124	18	5C3Z9VE527ARM	AP63804AE	5
39867	AP63565	105	4C3Z12B599ABRM	AP65122	18	5C3Z9VE527BRM	AP63803AD	5
3990082	AP4943048	117	4C3Z12B599ABRM	AP65123	18	5C4Z9A543A	AP63661	19
3990105	AP4943048	117	4C3Z12B599ABRM	AP65124	18	5C4Z9A543B	AP63661	19
3990130	PFF19528	121	4C3Z2A451BA	AP63433	13, 29	6111800009	AP61000	126
3C2Z6B209AA	AP63448	29	4C3Z8501AC	AP63503	19	6112001101	AP63600	126
3C2Z6B209BA	AP63432	28	4C3Z8A616AA	AP63430	28	6120920001	AP61002	127
3C3U11000AB	AP83006	29	4C3Z9A543AARM	HP032X	20	6420920301	AP61005	127
3C3Z10884AA	AP63437	21, 36	4C3Z9B246F	AP0098	28	6421800009	AP61001	126
3C3Z11002AA	AP83006	29	4C3Z9E527AA	AP60901	17	6460900252	AP61003	127
3C3Z12A697AA	AP63462	22	4C3Z9E527BRM	AP60901	17	6460920201	AP61003	127
3C3Z12K073AA	AP63415	21, 35	4C3Z9F452A	AP63438R	23	6460920601	AP61003	127
3C3Z6584BA	AP0023	26	4C3Z9F452ARM	AP63438R	23	6460920701	AP61003	127
3C3Z6766CA	RK31821	31, 41	4C3Z9F838A	AP63460	22	6472000101	AP63601	126
3C3Z6A642CA	AP63451	18	4C3Z9F838AB	AP63460	22	68003402AA	AP63533	122
3C3Z6C315AA	AP63412	21, 35	4C3Z9J460A	AP63403	9, 21	68197867AA	PFF54529	123
3C3Z8501A	AP63502	19	4C3Z9P456AC	AP63446	18	68197868AA	PFRK54553	123
3C3Z8575AA	AP63496	19	4C3Z9P456AF	AP63446	18	68197868AB	PFRK54553	123
3C3Z9229AA	AP0002	26	4C3Z9P456AH	AP63446	18	6901-PP	AP60800	17, 61
3C3Z9433BE	AP63447	28	4C3Z9P456AJ	AP63446	18	6902-PP	AP60801	17, 61
3C3Z9A543AARM	HP032X	20	4R8Z12A697A	AP63544	45	6903-PP	AP64800	33, 73
3C3Z9C407AB	AP63426	29	5010118R91	AP63503	62	6904-PP	AP64801	73
3C3Z9C968AA	AP63416	23	5010359R93	AP64900	73	6905-PP	AP66876	91
3C3Z9E527ABRM	AP60900	17	5010561R91	AP66918	92	6906-PP	AP66877	91
3C3Z9E527AE	AP60900	17	5010656R92	AP66976	91	6907-PP	AP66878	91
3C3Z9E527EARM	AP60900	17	5010657R92	AP66977	91	6908-PP	AP66879	91
3C3Z9E527EBRM	AP60900	17	5010658R92	AP66978	91	6909-PP	AP66889	91
3C3Z9E527ECRM	AP60900	17	5010659R92	AP66979	91	6910-PP	AP66892	91
3C3Z9F838EA	AP63407	22	5010682R92	AP63438R	66	6911-PP	AP66895	92

OEM PART NUMBER CROSS REFERENCE

OEM Part Number	AP Part Number	Page(s)	OEM Part Number	AP Part Number	Page(s)	OEM Part Number	AP Part Number	Page(s)
6912-PP	AP66818	92	8976028032	AP53904	130	98045060	AP0049	109
6913-PP	AP66821	92	8976097904	AP53906	130	98061571	AP91000	107
6914-PP	AP66857	92	8976097915	AP53907	130	98094201	AP63449	111
6915-PP	AP66855	92	8981106074	AP53808	131	98110607	AP53808	131
6916-PP	AP66858	92	8982816111	AP53809	131	98281611	AP53809	131
6918-PP	AP60900	17, 61	8C349F479AA	AP63476	37	9C2Z9G282A	AP63431	29
6919-PP	AP60901	17, 61	8C3Z12A697B	AP63463	22, 36	9C3Z5H221A	AP70001	35
6920-PP	AP64900	33, 73	8C3Z12B591A	AP63470	36	9C3Z5H221B	AP70000	35
6921-PP	AP64901	73	8C3Z12B591E	AP63471	37	9U2Z12A648A	AP63490	8
6922-PP	AP66976	91	8C3Z12K073A	AP63415	21, 35	A6111800009	AP61000	126
6923-PP	AP66977	91	8C3Z6A642A	AP63468	34	A6120920001	AP61002	127
6924-PP	AP66978	91	8C3Z8501B	AP63504	34	A6421800009	AP61001	126
6925-PP	AP66979	91	8C3Z8575D	AP63498	34	AE5Z12A647A	AP63493	21, 35
6926-PP	AP66989	91	8C3Z8A616S	AP63518	40	AFLS166	AP63524	45
6927-PP	AP66992	91	8C3Z9229A	AP0027	38	AFLS179	AP63475	37
6928-PP	AP66995	92	8C3Z9A543B	AP63643, AP63645	34	AFLS181RM	AP63494	23
6929-PP	AP66918	92	8C3Z9A543DRM	AP63643, AP63645	34	AU5Z12A647B	AP63454	19
6930-PP	AP66921	92	8C3Z9D475D	AP63456	37	BC3Z10346A	AP83009	48
6931-PP	AP66957	92	8C3Z9D476A	AP0042	39	BC3Z10346B	AP83010	48
6932-PP	AP66955	92	8C3Z9D930AA	AP63515	38	BC3Z10346C	AP83011	48
6933-PP	AP66958	92	8C3Z9D930BA	AP63516	38	BC3Z10346D	AP83009	48
6C2Z9G282AA	AP63431	29	8C3Z9E527A	AP64900	33	BC3Z11002A	AP83008	49
6C3A2A451BA	AP63433	13, 29	8C3Z9E527A	AP64800	33	BC3Z12B533A	AP63525	42
6C3Z2A451A	AP63433	13, 29	8C3Z9E527DRM	AP64900	33	BC3Z12B533B	AP63525	42
6C3Z6C640A	AP63455	19	8C3Z9E527DRM	AP64800	33	BC3Z12B579A	AP63524	45
6C3Z6C640AA	AP63455	19	8C3Z9F459A	AP63520	33	BC3Z12K073A	AP63535	43
6C3Z6C640C	AP63454	19	8C3Z9F479A	AP63476	37	BC3Z2A451A	AP63725	49
6C3Z6C640CA	AP63454	19	8C3Z9G282A	AP63450	41	BC3Z5J225L	AP63521	45
6C3Z9C407AA	AP63426	29	9C3Z9G282AC	PPF58529	41	BC3Z6B209A	AP63538	48
6C3Z9C407AA	PPF58054	31	8C3Z9G756A	AP63422	36	BC3Z6C315A	AP63534	44
6C3Z9G282AA	AP63426	29	8C3Z9J460A	AP63423	36	BC3Z7H141A	AP63497	23, 37, 45
6C3Z9G282C	AP63431	29	8C3Z9J460D	AP63473	37	BC3Z8501A	AP63507	43
6E7Z9350D	PPF58565	30	8C3Z9T514C	AP63482	40	BC3Z8501B	AP63505	43
6E7Z9A543BRM	AP63662	20	8E7Z9A543CRM	AP63663	20	BC3Z8501C	AP63505	43
6U5Z9278D	AP63539	44	94392261	AP53800	130	BC3Z8575A	AP63540	42
7079720C91	PPF58529	79	97188720	AP63720	16	BC3Z8575B	AP63541	42
7080839C92	AP63642	74	97188721	AP63721	106	BC3Z8575C	AP63542	42
7081021C1	AP63480	74	97188722	AP63722	106	BC3Z9229A	AP0087	46
7081213C91	AP63585	78	97188723	AP63723	106	BC3Z9229B	AP0088	47
7093938C91	AP63690	93	97216136	AP63562	107	BC3Z9D475C	AP63522	46
7093939C91	AP63681	93	97228188	AP63566	107	BC3Z9D475D	AP63523	46
7849209	AP63701	104	97228929	AP0059	106	BC3Z9F479B	AP63543	45
792593-0001	AP91000	23, 46, 107	97288625	AP63449	111	BC3Z9G282E	AP63527	42
7C3Z11002AA	AP83007	41	97329062	AP63449	111	BC3Z9J460B	AP63526	44
7C3Z12B579A	AP63475	37	97601156	AP53905	130	BC3Z9J460C	AP63529	45
7C3Z6B209B	AP63517	40	97601259	AP53801	130	BC3Z9J460E	AP63526	44
7C3Z6B209E	AP63519	40	97602436	AP53802	130	BC3Z9J60D	AP63537	44
7C3Z8A616F	AP63499	40	97602803	AP53904	130	BC3Z9N184B	AP61004	49
7C3Z8B552A	AP63472	33	97609790	AP53906	130	BRPV-1	AP63703	29
7C3Z9J454A	AP0164	35	97609791	AP53907	130	BRPV-5	AP63724	14
88864234	S14-101DAM	111	97780100	AP53903	130	BRPV-6	AP63700	14
88894035	AP63561	102	97780452	AP53904	130	BRPV-7	AP63433	13, 29
88894036	AP63560	102	97780453	AP53905	130	BRPV-8	AP63725	49
88917036	PFL5515	111	97780454	AP53906	130	BT122	AP63519	40
89003343	AP63449	111	97780455	AP53907	130	BT131	AP63538	48
89017558	AP63702	104	98017645	PPF50216	112	BT50	AP63421	13
8943921602	AP53800	130	98031233	AP63563	107	BT591	AP63517	40
8943922614	AP53800	130	98045055	AP0050	109	CM5054	AP63416	23
8973297035	AP53903	130	98045056	AP0051	109	CM5055	AP0002	26
8976011562	AP53905	130	98045057	AP0052	110	CM5126	AP63417	23
8976012592	AP53801	130	98045058	AP0047	109	CM5191	AP0087	46
8976024362	AP53802	130	98045059	AP0048	109	CM5192	AP0088	47

OEM PART NUMBER CROSS REFERENCE

OEM Part Number	AP Part Number	Page(s)	OEM Part Number	AP Part Number	Page(s)	OEM Part Number	AP Part Number	Page(s)
CX1679	AP63492	10	F6TZ9155AB	AP63424	15	PW491	AP63503	19
CX1961	AP63495	22	F6TZ9157BA	AP0008	12	PW502	AP63507	43
CX2020	AP63439R	23	F6TZ9350A	APM61067	6	PW503	AP63505	43
CX2056	AP63438R	23	F6TZ9A543ARM	HP005X	7	PW504	AP63505	43
CX2161	AP63476	37	F6TZ9C977AN	AP0003	12	RT1169	AP63496	19
CX2404	AP63522	46	F6TZ9F838A	AP63418	9	RT1205	AP63540	42
CX2405	AP63523	46	F7TZ12B533A	AP63405	10	RT1206	AP63541	42
CX2432	AP63543	45	F7TZ12B533CA	AP63405	10	RT1207	AP63542	42
CX2466RM	AP63439R	23	F7TZ12B599AC	AP65110	6	RT1212	AP63498	34
CX2467RM	AP63438R	23	F7TZ12K073A	AP63400	8	RT1231	AP63540	42
D1808A	AP63419	103	F7TZ12K073B	AP63400	8	RY383	AP63420	103
DC3Z9J460D	AP63528	44	F7TZ6A636AAA	AP0004	12	RY525	AP63405	10
DPFE1	AP63429	9	F7TZ9E527ARM	AP63800AA	5	SA1004	AP83008	49
DPFE17	AP63473	37	F7TZ9E527BRM	AP63801AB	5	SA965	AP83007	41
DPFE20	AP63529	45	F81Z12B533AC	AP63405	10	SW5267	AP63435	9, 21, 36
DPFE21	AP63537	44	F81Z2A451BA	AP63433	13, 29	SW6052	AP63437	21, 36
DPFE22	AP63526	44	F81Z6584AA	AP0014	13	SW6357	AP63539	44
DPFE24	AP63528	44	F81Z6N653BA	AP63461	13	TP1298B	PFF50216	112
DPFE3	AP63403	9, 21	F81Z8501ARM	AP63501	7	TP3018	PFF50216	112
DPFE6	AP63408	22	F81Z8501CRM	AP63501	7	W301386	AP0028	26
DPFE7	AP63423	36	F81Z9155AC	AP63425	15	W301390	AP0028	26
DPFE8	AP63423	36	F81Z9278AA	AP63435	9, 21, 36	W302209	AP0028	26
DU87	AP63491	8	F81Z9A543BRM	HP007X	8	XC3Z12B599AA	AP65120	6
DU88	AP63415	21, 35	F81Z9A543CRM	HP008X	8	XC3Z9E527AARM	AP63804AE	5
DU92	AP63535	43	F81Z9C065AA	AP0007	12	YB3125	AP63499	40
DY1112	AP63463	22, 36	F81Z9C407AC	69136	6	YB3126	AP63518	40
DY1137	AP63493	21, 35	F81Z9C968AA	AP63402	10	YB632	AP63430	28
DY1144	AP63436	9	F81Z9C968AB	AP63402	10	YC3Z12B533AA	AP63406	5, 17, 33
DY1145	AP63490	8	F81Z9D930AB	AP63413	11	YC3Z9350CA	APM61067	6
DY1146	AP63544	45	F81Z9E527BRM	AP63801AB	5			
DY1148	AP63534	44	F81Z9E527CRM	AP63803AD	5			
DY1160	AP63545	43	F81Z9E527DRM	AP63800AA	5			
DY1261	AP63525	42	F81Z9E527EARM	AP63804AE	5			
DY708	AP63489	9	F81Z9J294AA	AP63410	6			
DY861	AP63405	10	F81Z9229AA	AP0001	12			
DY876	AP63406	10	F8UZ6B209CA	AP63421	13			
DY961	AP63436	9	F8UZ9F479BA	AP63492	10			
DY984	AP63462	22	FD3375	PFF829B	14			
DY985	AP63412	21, 35	FD4495	PFF4595	14			
EP1000	AP63441	102	FD4596	PFF4596	15			
EP1001	AP63442	106	FD4604	PFF4616	30			
EP1020	AP63442	106	FD4606	PFF4606	30			
EP309	AP63440	102	FD4609	PFF4617	41			
F4TZ12K073C	AP63491	8	FG1054	AP63424	15			
F4TZ2A451A	AP63724	14	FG1057	AP63425	15			
F4TZ6584A	AP0013	13	FL2016	APFL2016	30, 41			
F4TZ6A636A	AP0004	12	GL8754	AP83009	48			
F4TZ9A543BRM	HP004X	7	GL992	AP83009	48			
F4TZ9C968C	AP63401	10	GL993	AP83010	48			
F4TZ9C968CB	AP63401	10	GL994	AP83011	48			
F4TZ9D930K	AP63414	11	HC2Z12B599ARM	AP65120	6			
F4TZ9F479A	AP63489	9	HC2Z12B599BRM	AP65110	6			
F4TZ9F538A	AP63411	54	PF2232	PFL5515	111			
F4TZ9VE527AARM	AP63800AA	5	PFB101	AP63426	29			
F5AZ12A648AB	AP63436	9	PFB103	AP63527	42			
F5TZ9151A	AP0008	12	PFB93	AP63426	29			
F5TZ9G270A	RK31019	15	PFB95	AP63450	41			
F5TZ9J294A	AP63409	6	PFB98	AP63431	29			
F61Z9VE527BRM	AP63801AB	5	PFF5550	PFF4617	41			
F61Z9VE527ERM	AP63804AE	5	PT121	AP0022	103			
F6TZ2A451AA	AP63700	14	PW480	AP63502	19			
F6TZ8501AARM	AP63501	7	PW482	AP63504	34			

ALLIANT POWER PART NUMBER INDEX

AP Part Number	Page(s)	AP Part Number	Page(s)	AP Part Number	Page(s)	AP Part Number	Page(s)
69136	6	AP0061	27	AP0519	133	AP63425	15
228000-2292	120	AP0062	108	AP0520	133	AP63426	29
428000-5940	120	AP0063	108	AP0521	133	AP63427	118
AP0001	12, 58, 85, 89	AP0064	39	AP0522	133	AP63428	118
AP0002	26, 68	AP0065	39	AP0523	133	AP63429	9, 84
AP0003	12, 58, 85	AP0067	104	AP0524	133	AP63430	28
AP0004	12, 58	AP0068	11, 25, 46, 57, 68, 85, 97, 107	AP0525	133	AP63431	29
AP0005	26, 68			AP0526	133	AP63432	28
AP0006	86, 98	AP0070	27, 69	AP0528	133	AP63433	13, 29
AP0007	12	AP0071	39	AP0529	133	AP63434	83
AP0008	12	AP0072	77	AP3035342	116	AP63435	9, 21, 36, 64
AP0009	10, 57	AP0073	78	AP3035344	116	AP63436	9
AP0010	10, 57	AP0076	38	AP4024808	116	AP63437	21, 36, 64, 75, 95
AP0011	12, 58	AP0086	27	AP4024809	116	AP63438R	23, 66
AP0012	119	AP0087	46	AP4089602	117	AP63439R	23
AP0013	13, 59	AP0088	47	AP4943048	117	AP63440	102
AP0014	13, 59	AP0090	98	AP4988747	117	AP63441	102
AP0015	11, 57	AP0091	122	AP53800	130	AP63442	106
AP0016	11, 57	AP0092	119	AP53801	130	AP63443	103
AP0018	24, 67, 97	AP0093	120	AP53802	130	AP63444	103
AP0019	24, 67, 97	AP0094	120	AP53904	130	AP63445	18, 61
AP0020	25, 68, 97	AP0095	105	AP53905	130	AP63446	18, 62
AP0021	11, 24, 38, 57, 67, 76, 85, 97	AP0097	122	AP53906	130	AP63447	28, 70
		AP0098	28	AP53907	130	AP63448	29
AP0022	103	AP0099	28	AP53808	131	AP63449	111
AP0023	26, 68	AP0127	110	AP53809	131	AP63450	41
AP0024	103	AP0128	110	AP53903	130	AP63451	18, 62
AP0025	98	AP0129	110	AP60800	17, 61	AP63452	7, 54, 83
AP0026	98	AP0130	110	AP60801	17, 61	AP63453	119
AP0027	38, 77	AP0134	40	AP60900	17, 61	AP63454	19
AP0028	26, 69	AP0149	99	AP60901	17, 61	AP63455	19
AP0029	108	AP0150	131	AP61000	126	AP63456	37
AP0030	24, 67	AP0151	131	AP61001	126	AP63457	107
AP0031	25	AP0152	47	AP61002	127	AP63458	118
AP0032	25	AP0153	47	AP61003	127	AP63459	66
AP0033	25	AP0154	109	AP61004	49	AP63460	22, 65
AP0034	104	AP0155	109	AP61005	127	AP63461	13, 59
AP0035	26, 69	AP0156	47	AP63400	8, 56	AP63462	22, 65, 96
AP0036	86	AP0157	48	AP63401	10, 56, 84	AP63463	22, 36, 65, 75
AP0038	86	AP0161	99	AP63402	10, 56, 84	AP63464	85
AP0039	26, 69	AP0162	111	AP63403	9, 21, 56, 64	AP63465	84
AP0040	24, 67	AP0163	99	AP63404	7	AP63466	84
AP0041	39, 77	AP0164	35	AP63405	10, 56	AP63467	117
AP0042	39, 77	AP0500	132	AP63406	5, 17, 33	AP63468	34, 73
AP0043	27	AP0501	132	AP63407	22, 65	AP63470	36, 76
AP0044	27	AP0502	132	AP63408	22, 64	AP63471	37, 76, 96
AP0045	108	AP0503	132	AP63409	6, 54	AP63472	33
AP0046	108	AP0504	132	AP63410	6, 54, 61	AP63473	37
AP0047	109	AP0505	132	AP63411	7, 54	AP63474	64, 75, 95
AP0048	109	AP0506	133	AP63412	21, 35, 75, 95	AP63475	37
AP0049	109	AP0507	133	AP63413	11, 58	AP63476	37, 65, 76, 96
AP0050	109	AP0508	133	AP63414	11, 58	AP63478	117
AP0051	109	AP0509	133	AP63415	21, 35, 64, 75, 95	AP63479	66
AP0052	110	AP0510	133	AP63416	23, 66	AP63480	74
AP0053	119	AP0511	133	AP63417	23, 66	AP63481	28, 70
AP0054	120	AP0512	133	AP63418	9, 56	AP63482	40
AP0055	120	AP0513	132	AP63419	103	AP63483	78
AP0056	24, 38, 67, 76, 97	AP0514	132	AP63420	103	AP63484	78
AP0057	69	AP0515	132	AP63421	13	AP63485	105
AP0058	119	AP0516	132	AP63422	36, 75	AP63486	105
AP0059	106	AP0517	132	AP63423	36, 65, 75, 95	AP63489	9
AP0060	27	AP0518	132	AP63424	15	AP63490	8

ALLIANT POWER PART NUMBER INDEX

AP Part Number	Page(s)	AP Part Number	Page(s)	AP Part Number	Page(s)	AP Part Number	Page(s)
AP63491	8, 55	AP63561	102	AP65124	18	PFL5515	111
AP63492	10	AP63562	107	AP66818	92	PFP58054	31
AP63493	21, 35	AP63563	107	AP66821	92	PFP58529	41, 79
AP63494	23	AP63564	105	AP66855	92	PFP58565	30
AP63495	22	AP63565	105	AP66857	92	PFRK20567	14
AP63496	19	AP63566	107	AP66858	92	PFRK50309	113
AP63497	23, 37, 45	AP63567	95	AP66876	91	PFRK54553	123
AP63498	34	AP63580	83	AP66877	91	RK21113	79
AP63499	40	AP63581	54	AP66878	91	RK31019	15, 59
AP63501	7	AP63582	93	AP66879	91	RK31449	15, 71
AP63502	19	AP63583	62	AP66889	91	RK31821	31, 41, 71, 79
AP63503	19, 62	AP63585	78	AP66892	91	RK32138	31
AP63504	34	AP63600	126	AP66895	92	RK42043	113
AP63505	43	AP63601	126	AP66918	92	RK58010	112
AP63507	43	AP63642	74	AP66921	92	RK58052	30
AP63512	96	AP63643	34	AP66955	92	S14-101DAM	111
AP63513	96	AP63644	74	AP66957	92		
AP63514	96	AP63645	34	AP66958	92		
AP63515	38, 76	AP63661	19, 62	AP66976	91		
AP63516	38, 77	AP63662	20, 63	AP66977	91		
AP63517	40	AP63663	20, 63	AP66978	91		
AP63518	40	AP63690	93	AP66979	91		
AP63519	40	AP63681	93	AP66989	91		
AP63520	33	AP63694	94	AP66992	91		
AP63521	45	AP63695	94	AP66995	92		
AP63522	46	AP63696	94	AP70000	35		
AP63523	46	AP63697	94	AP70001	35		
AP63524	45	AP63692	93	AP83006	29		
AP63525	42	AP63693	93	AP83007	41		
AP63526	44	AP63700	14	AP83008	49		
AP63527	42	AP63701	104	AP83009	48		
AP63528	44	AP63702	104	AP83010	48		
AP63529	45	AP63703	29	AP83011	48		
AP63531	118	AP63720	106	AP91000	23, 46, 107		
AP63532	118	AP63721	106	APE65110	104		
AP63533	122	AP63722	106	APM61067	6, 54		
AP63534	44	AP63723	106	BG	82		
AP63535	43	AP63724	14	HP004X	7, 55		
AP63537	44	AP63725	49	HP005X	7, 55		
AP63538	48	AP63800AA	5, 53	HP007X	8, 55		
AP63539	44	AP63801AB	5, 53	HP008X	8, 55		
AP63540	42	AP63802AC	53	HP020X	83		
AP63541	42	AP63803AD	5, 53	HP021X	83		
AP63542	42	AP63804AE	5, 53	HP022X	83		
AP63543	45	AP63805BA	81, 88	HP032X	20, 63		
AP63544	45	AP63806BB	81	PFF19528	121		
AP63545	43	AP63807BC	81	PFF19579	121		
AP63546	105	AP63808BD	81, 88	PFF31795	30, 70		
AP63547	105	AP63809BE	81	PFF32715	79		
AP63548	105	AP63810BF	81, 88	PFF33286	79		
AP63549	105	AP63811BI	82, 88	PFF4245R2-02	111		
AP63550	105	AP63812BJ	82, 88	PFF4595	14, 59		
AP63551	105	AP63813BN	82, 89	PFF4596	15, 71		
AP63552	105	AP63814BP	82, 89	PFF4606	30		
AP63553	105	AP64800	33, 73	PFF4616	30, 70		
AP63554	105	AP64801	73	PFF4617	41		
AP63555	105	AP64900	33, 73	PFF50216	112		
AP63556	105	AP64901	73	PFF54529	123		
AP63557	105	AP65110	6	PFF58567	112		
AP63558	105	AP65120	6	PFF829B	14		
AP63559	105	AP65122	18	PFFRK51216	113		
AP63560	102	AP65123	18	PFL2016	30, 41, 70, 78		

TRADEMARKS

AGCO® is a registered trademark of AGCO Corporation

ARP® is a registered trademark of Automotive Racing Products, Inc.

Bosch® is a registered trademark licensed by Robert Bosch GmbH, Germany.

Caterpillar® and CAT® are registered trademarks of Caterpillar, Inc.

Cummins®, ISB®, and B-Series® are registered trademarks of Cummins Engine Company, Inc.

Detroit Diesel® and Series 50/60® are registered trademarks of Detroit Diesel Corporation.

Dodge® and Ram® are registered trademarks of Chrysler Group, LLC.

DMAC® is a registered trademark of DMAX Ltd.

Ford®, Motorcraft®, and Power Stroke® are registered trademarks of Ford Motor Company.

Freightliner® is a registered trademark of Daimler AG.

F Series®, F-250®, F-350®, F-450®, F-550®, F-650®, F-750®, E Series®, Econoline®, and Excursion®, are registered trademarks of Ford Motor Company.

GM®, GMC®, Chevrolet®, Chevy®, Duramax®, Express®, Savana®, Sierra®, Silverado® are registered trademarks of General Motors, LLC.

HEUI® is a registered trademark of Caterpillar, Inc.

IH® is a registered trademark of CNH America, LLC.

Isuzu® is a registered trademark of Isuzu Motors America LLC.

International® and MaxxForce® are registered trademarks of International Truck Intellectual Property Company, LLC.

Jeep®, Jeep Liberty®, and Jeep Grand Cherokee® are registered trademarks of Chrysler Group, LLC.

John Deere® is a registered trademark of Deere & Company.

Mack® and Mack Trucks® are registered trademarks of Volvo AB.

M-B®, OM®, and Mercedes-Benz® are registered trademarks of Daimler AG.

Navistar® is a registered trademark of Navistar International Corporation.

Perkins® and 1300 Series EDi® are registered trademarks of Perkins Engines Company Limited, a subsidiary of Caterpillar, Inc.

Racor® is a registered trademark of Parker Hannifin Corp.

Siemens® is a registered trademark of Siemens AG.

Sprinter® and/or Mercedes-Benz® Sprinter are registered trademarks of Daimler AG.

Stanadyne® and PurePower Technologies® are registered trademarks of Stanadyne Corporation.

All other manufacturer names, models, part numbers, and product images used herein are for reference purposes only.



Follow along with [#AlliantPower](#)
on our social media channels!



6167 Pepsi Way, Windsor, WI 53598 ▶ 608.842.5180 ▶ 866.283.1785 ▶ fax: 608.842.5150 ▶ [AlliantPower.com](#)



©2019 Alliant Power – A Diesel Forward Company All Rights Reserved

APG0619